

# Operator's Manual

## SMARTROLL™ RDO Handheld Instrument



---

Copyright © 2013 by In-Situ Inc. All rights reserved.

This document contains proprietary information which is protected by copyright. No part of this document may be photocopied, reproduced, or translated to another language without the prior written consent of In-Situ Inc.

**Mailing and Shipping  
Address:**

In-Situ Inc.  
221 East Lincoln Avenue  
Fort Collins, CO 80524  
U.S.A.

**Phone:** 970-498-1500 (international & domestic)

**Fax:** 970-498-1598

**Internet:** [www.in-situ.com](http://www.in-situ.com)

**Support:** 800-446-7488 (U.S.A. & Canada)

In-Situ Inc. makes no warranty of any kind with regard to this material, including, but not limited to, its fitness for a particular application. In-Situ will not be liable for errors contained herein or for incidental or consequential damages in connection with the furnishing, performance, or use of this material.

In no event shall In-Situ Inc. be liable for any claim for direct, incidental, or consequential damages arising out of, or in connection with, the sale, manufacture, delivery, or use of any product.

In-Situ and the In-Situ logo, Win-Situ, TROLL, Baro Merge, BaroTROLL, HERMIT, iSitu, Pocket-Situ, RDO, RuggedCable, RuggedReader, TROLL, and Win-Situ are trademarks or registered trademarks of In-Situ Inc. Microsoft and Windows are registered trademarks of Microsoft Corporation. Pentium is a registered trademark of Intel. Tefzel and Delrin are registered trademarks of E. I. DuPont de Nemours and Company. Viton is a registered trademark of DuPont Dow Elastomers. Kellems is a registered trademark of Hubbell Inc. Alconox is a registered trademark of Alconox Company. Lime-A-Way is a registered trademark of Reckitt Benckiser. iPod and iPhone are trademarks of Apple Inc., registered in the U.S. and other countries. The Bluetooth word mark and logos are registered trademarks owned by the Bluetooth SIG, Inc. and any use of such marks by In-Situ Inc. is under license. NIST is a registered trademark of the National Institute of Standards and Technology, U.S.A. Other brand names and trademarks are property of their respective owners.



The presence of the Waste Electrical and Electronic Equipment (WEEE) marking on the product indicates that the device is not to be disposed via the municipal waste collection system of any member state of the European Union.

For products under the requirement of WEEE directive, please contact your distributor or local In-Situ Inc. office for the proper decontamination information and take back program, which will facilitate the proper collection, treatment, recovery, recycling, and safe disposal of the device.

0099322 | Rev. 002

---

## Table of Contents

---

<b>1 Introduction</b> .....	<b>5</b>
Scope .....	5
Serial Number Location .....	5
<b>2 Safety</b> .....	<b>5</b>
<b>3 General Specifications</b> .....	<b>6</b>
<b>4 Sensor Specifications</b> .....	<b>7</b>
Dissolved Oxygen RDO Fast Cap (Optical Sensor) Specifications .....	7
Sample Temperature Sensor Specifications (Probe) .....	7
Fixed Salinity Correction .....	7
Barometric Pressure Sensor Specifications (Battery Pack) .....	8
Air Temperature Sensor Specifications (Battery Pack) .....	8
<b>5 Battery Pack Specifications</b> .....	<b>9</b>
<b>6 Instrument Overview</b> .....	<b>10</b>
Instrument Description .....	10
<b>7 System Components</b> .....	<b>10</b>
Probe Dimensions with Restrictor On .....	11
Probe Dimensions with Restrictor Off .....	11
<b>8 System Setup</b> .....	<b>12</b>
Install the Batteries .....	12
Installing the Sensor and Cable .....	13
<b>9 iSitu Overview</b> .....	<b>14</b>
About the iSitu App .....	14
Connect the Instrument to the iSitu App .....	15
Live Readings Screen .....	17
Change Parameters and Units .....	18
<b>10 iSitu Sites</b> .....	<b>18</b>
About Sites .....	18
Create a New Site .....	19
Select a Site .....	20
Edit a Site .....	21
Delete a Site .....	21
Restore a Site .....	21
<b>11 iSitu Data</b> .....	<b>22</b>
About Data .....	22
Salinity Value in Data Log .....	22
Record Data .....	23

---



---

View an Individual Reading .....	24
View and Email Data from the Selected Site .....	26
View, Email, or Delete Data from Any Site .....	29
Emailing Data From Different Screens in iSitu .....	31
Emailing from the Data screen .....	31
Emailing from the Logs screen .....	31
Emailing from the Readings screen .....	31
Emailing from the Data Details screen .....	31
Transfer Data to a Computer .....	31
Delete all Logs by Site .....	32
Restore Data .....	32
<b>12 iSitu Calibration .....</b>	<b>33</b>
About Calibration .....	33
Calibrate the Rugged Dissolved Oxygen Sensor .....	33
<b>13 Care and Maintenance .....</b>	<b>37</b>
Maintenance Schedule .....	37
User-Serviceable Parts .....	37
O-rings .....	37
RDO Fast Sensor Cap Replacement .....	37
Cleaning the RDO Sensor .....	37
Clean the Sensor Cap .....	37
Clean the Optical Window .....	38

---

## Introduction

This manual is intended to describe the characteristics, operation, calibration, and maintenance of the SmarTROLL™ RDO Handheld Instrument.

### Scope

This manual covers the following information.

Chapter 1—Introduction

Chapter 2—Safety

Chapter 3—Overview

Chapter 4—System Components

Chapter 5—Probe Setup

Chapter 6—iSitu Overview

Chapter 7—iSitu Sites

Chapter 8—iSitu Data

Chapter 9—RDO Sensor Calibration

Chapter 10—Care and Maintenance

### Serial Number Location

The probe serial number is engraved on the probe body.

The battery pack serial number is on a sticker affixed to the battery pack casing.

### Safety

Do not submerge the battery pack or the mobile display device in liquid.



Ensure that the RDO Sensor Cap is pressed firmly over the sensor lens and is flush with the instrument before submerging in liquid.

Replace the cable if insulation or connectors are damaged.

Make sure the probe and sensor O-rings are clean and free of damage.

---

## General Specifications

Operating temperature	-5 to 50° C (23 to 122° F)
Storage temperature	-40 to 65° C (-40 to 149° F)
Diameter	2.61 cm (1.03 in.) 2.84 cm (1.12 in.) with guard installed
Dimensions	2.8 cm x 16.76 cm (1.12 in. x 6.60 in.) D x L with guard installed
Weight	255 g (0.56 lbs)
Wetted materials	Acetal, Titanium, 316SS, Viton, PC/PMMA
Environmental rating	IP68 with all sensors and cable attached. IP67 with sensors removed and cable detached.
Reading rate	1 reading every 10 seconds; data logged to iOS device.
Power	6 VDC from battery pack
Interface	iPhone® 4S, iPod touch® 5, or iPad® 3, 4, mini or later; iOS 6.0 or later. Bluetooth® Low Energy (BLE) radio. Purchase the iSitu™ App at the Apple® App Store.
Cable	Black polyurethane. Standard lengths available: 1.5 m, 4.6 m, 9.1 m (5 ft, 15 ft, 30 ft)
Warranty	2-years
Certifications	CE, FCC, WEEE
Notes	Specifications are subject to change without notice. Apple, iPhone, iPod touch, and iPad are trademarks of Apple Inc. registered in U.S. and other countries. Bluetooth is a registered trademark of Bluetooth SIG, Inc. Viton is a registered trademark of DuPont Performance Elastomers L.L.C.

---

## Sensor Specifications

### Dissolved Oxygen RDO Fast Cap (Optical Sensor) Specifications

Accuracy	$\pm 0.1$ mg/L; $\pm 0.2$ mg/L; $\pm 10\%$ of reading
Range	0 to 8 mg/L; 8 to 20 mg/L; 20 to 50 mg/L; Full operating range: 0 to 50 mg/L
Resolution	0.01 mg/L
Sensor Type	Fixed with replaceable RDO Fast Cap (life: 1 year typical)
Response Time	T90: <30 sec. T95: <45 sec.
Units of Measure	mg/L, % saturation, ppm
Methodology	EPA-approved In-Situ Methods 1002-8-2009 1003-8-2009 1004-8-2009

### Sample Temperature Sensor Specifications (Probe)

Accuracy	$\pm 0.1^{\circ}$ C
Range	-5 to 50 $^{\circ}$ C (23 to 122 $^{\circ}$ F)
Resolution	0.01 $^{\circ}$ C or better
Sensor Type	Fixed
Response Time	<30 sec.
Units of Measure	Celsius, Fahrenheit
Methodology	EPA 170.1

### Fixed Salinity Correction

Fixed Salinity Correction

User-set value to match the salinity of water sample  
Value appears in data log

---

## Barometric Pressure Sensor Specifications (Battery Pack)

Accuracy	±3 mbar max.
Range	300 to 1100 mbar
Resolution	0.01 mbar
Sensor Type	Fixed
Response Time	Instantaneous in thermal equilibrium
Units of Measure	psi, kPa, bar, mbar, mmHg, inHg, Torr, atm
Methodology	Piezoresistive pressure sensor

## Air Temperature Sensor Specifications (Battery Pack)

Accuracy	±2° C
Range	-20 to 70° C (-4 to 158° F)
Resolution	0.1° C
Sensor Type	Fixed
Response Time	<30 sec.
Units of Measure	Celsius, Fahrenheit
Methodology	EPA 170.1



---

## Battery Pack Specifications

<b>Battery Type</b>	<b>Four 1.5V AA lithium or alkaline batteries</b>
Operating temperature	-5 to 50° C (23 to 122° F); 95% relative humidity, non-condensing
Storage temperature	-40 to 65° C (-40 to 149° F); 95% relative humidity, non-condensing
Dimensions & weight	9.5 x 7.6 x 5.7 cm (3.75 x 3 x 2.25 in.) (H x D x W). Weight: 165 g (5.8 oz)
Materials	PC/ABS
Environmental rating	IP67 with battery cover closed
Output options	BLE radio
Battery type	4 AA Lithium or Alkaline
Warranty on battery pack	1-year
Warranty on cable	1-year

---

## *Instrument Overview*

### **Instrument Description**

The SmarTROLL™ RDO Handheld Instrument is comprised of a mobile display, battery pack, cable, and an integrated optical Rugged Dissolved Oxygen (RDO®) Sensor. The RDO Sensor Cap is replaceable.

### *System Components*

The system includes the following components.

- Integrated RDO Sensor
- RDO Fast Sensor Cap
- Stainless steel restrictor
- Calibration cup
- Battery pack and cable

#### Accessories Purchased Separately

- Replacement RDO Fast Sensor Cap
- Calibration Kit (includes calibration cup, 3 sponge wafers, vented cap, and storage cap)
- Cable 1.5 m (5 ft), 4.6 m (15 ft), 9.1 m (30 ft) and 30.5 m (100 ft.)
- Maintenance kit
- Replacement battery pack
- iPod® Touch (for instrument control and data display)
- iTunes® account for transferring data files as an alternate to email

## Probe Dimensions with Restrictor On

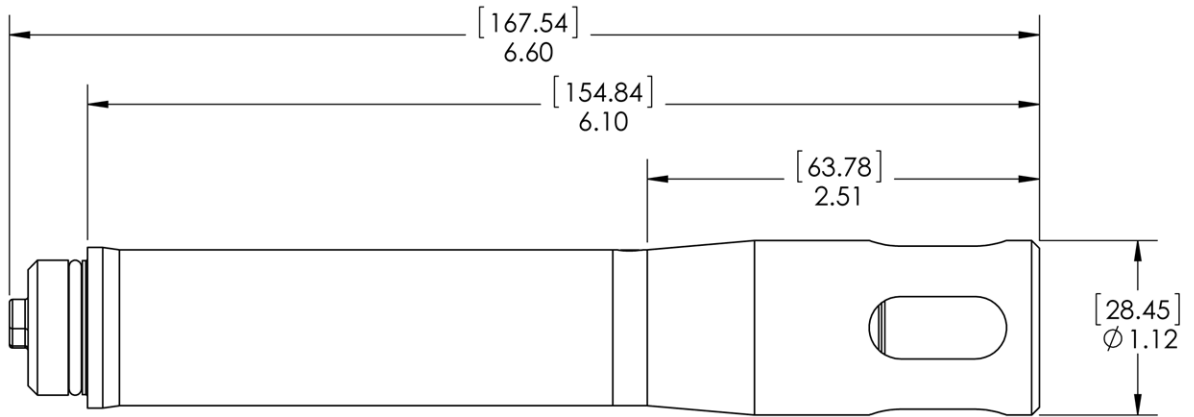

Total length with connector	167.54 mm (6.60 in.)
Total length without connector	154.84 mm (6.10 in.)
Restrictor length	63.78 mm (2.51 in.)
Diameter with restrictor	28.45 mm (1.12 in.)

## Probe Dimensions with Restrictor Off

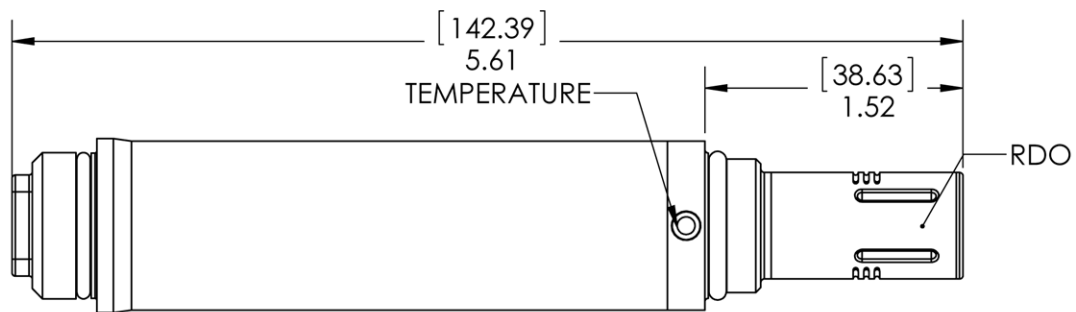

Total length with restrictor off	142.39 mm (5.61 in.)
Sensor length	38.63 mm (1.52 in.)

---

## System Setup

You will need to install batteries in the battery pack, install the RDO Sensor Cap on the probe, and attach the cable.

### Install the Batteries

The 4 AA batteries that are shipped with the battery pack are likely to last for 80 hours of continuous use.

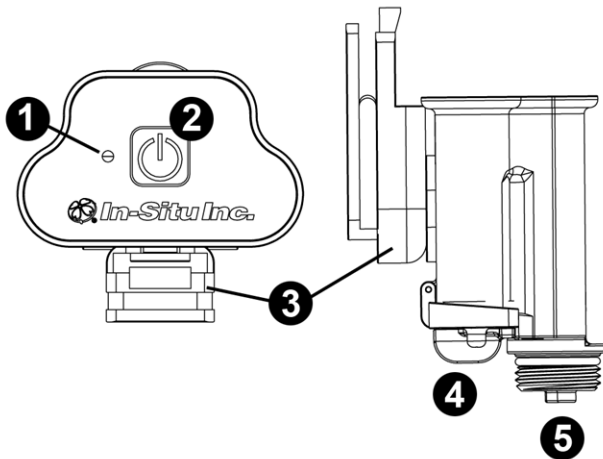

1	Power indicator
2	On/Off button
3	Belt clip
4	Battery compartment latch
5	Cable connection

1. Twist the cable connector counterclockwise to remove the cable from the battery pack.
2. Slide the lever on the battery compartment to release the cover.



3. Install the 4 AA batteries according to the +/- indicators engraved on the outside cover.



4. Close the cover and slide the lever to lock the compartment.

## Installing the Sensor and Cable

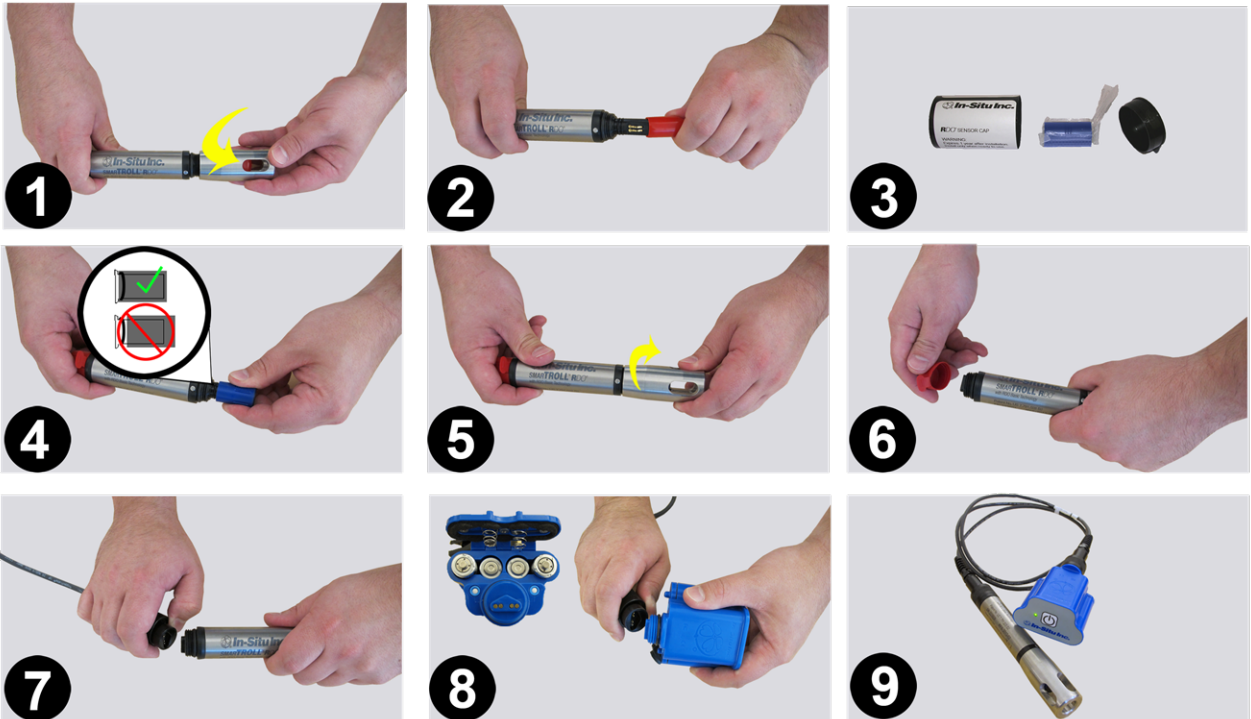

1. Twist the restrictor off the probe.
2. Remove the dust cap from the sensor lens.
3. Locate the RDO Sensor Cap container and remove the cap from the packaging.



Important: Avoid touching the sensor lens and the sensing material on top of the cap.

4. Align the flat edge of the RDO Sensor with the slotted edge of the RDO Cap and press the cap into position. Push until the cap is firmly in place.
5. Twist the restrictor onto the probe.
6. Remove the dust cap from the cable connector.
7. Align the pins on the cable with the pins on the probe, then twist the outer portion of the connector until the connection is secure.

8. Make sure the batteries are in the battery pack.
9. Align the pins on the cable with the pins on the battery pack, then twist the outer portion of the connector until the connection is secure.



Important: The RDO Sensor Cap must be installed firmly in place to prevent water from entering the instrument.

## *iSitu Overview*

### About the iSitu App

The iSitu App is the user interface and control application for In-Situ Inc. handheld water quality instruments. You can use iSitu on the Apple iPod Touch, and iPhone for up to five devices per purchased license.

iSitu allows you to accomplish the following tasks.

- View live readings that update every 10 seconds.
- Change parameters and units.
- Record data.
- Email data in spreadsheet format.
- Transfer data from mobile device to a computer.
- Organize data by Site location.
- Calibrate Sensors and View Reports

### *Estimated iPod Battery Life*

The table below shows the estimated battery life for the iPod. The values are dependent on the number of readings taken and the brightness setting on the display. To change brightness settings, see **Settings > Brightness & Wallpaper** on the iPod.

BRIGHTNESS					NUMBER OF READINGS	BATTERY TIME (HOURS)
MIN	1/4	1/2**	3/4	FULL		
X					2,500	6.9
	X				1,950	5.4
		X			1,700	4.7
			X		1,500	4.2
				X	1,050	3.3

\*Values provided assume location services and WiFi enabled. Disabling these features can provide an additional 0.5 to 1 hour of life.

\*\*Default

---

## Connect the Instrument to the iSitu App

1. Make sure that the cable is connected to the instrument and the battery pack.
2. Press the power button on the battery pack.
3. On the mobile device, tap **Settings**.



4. Turn Bluetooth on.



5. Press the Home button (round button on the mobile device frame) to show all apps.
6. Tap the iSitu icon  to open the iSitu App.
7. If you are prompted to allow iSitu to use your current locations, tap **OK**.



If you allow iSitu to use your current locations it will enable the mapping feature for site setup. If you select **Don't Allow**, you can change the setting later. **See Settings > Privacy Settings > Location Services.**

8. Live readings appear on screen.

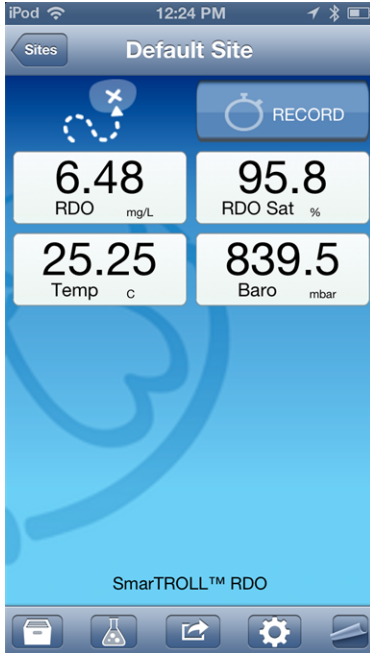



---

## Live Readings Screen

The Live Readings screen is also referred to as the Home screen. If you touch the **Home** icon within the app you will return here.

✓ Live readings update every 10 seconds.

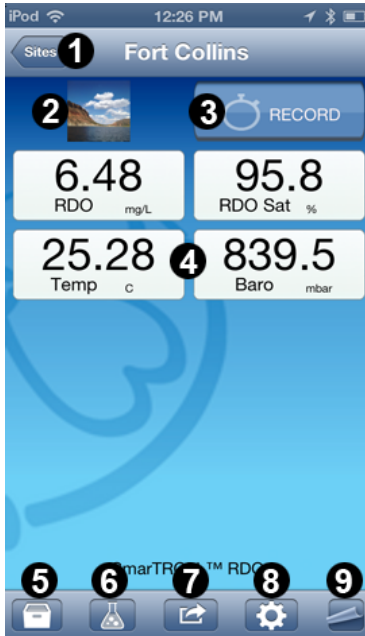

1	Sites button - setup sites, select another site
2	Site photo (optional)
3	Record/Stop button - records sensor readings every 10 seconds
4	Sensor readings - updated every 10 seconds
5	Data files - access files stored on the mobile device
6	Sensor calibration
7	View or email data
8	Access Low-Flow (additional purchase required)
9	Help

---

## Change Parameters and Units

1. From the **Home** screen, tap any parameter field.



2. Swipe the left side of the parameter pick wheel to find the appropriate parameter.
3. Swipe the right side of the parameter pick wheel to select the appropriate unit.
4. Tap the **Set** button to set the parameter and unit selection.

## *iSitu Sites*

### About Sites

A site represents the physical location at which the instrument collects data. For example, you can create a site to represent a lake, gauging station, well, tank, number, or nearby landmark.

If you do not set up a site, your data will be associated with **Default Site**. The site name is displayed at the top of the **Live Readings** screen.

Tap the **Sites** button to select or edit an existing site, or to create a new site.

---

## Create a New Site

1. From the **Live Readings** screen, tap the **Sites** button.

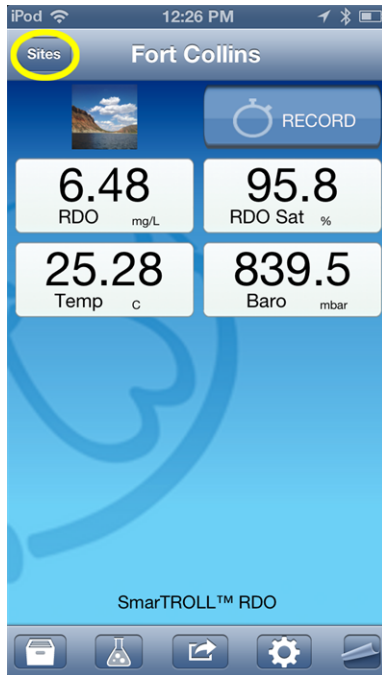

2. A list of existing sites appears.



3. Tap the **New Site** button. The **Site Details** screen appears.

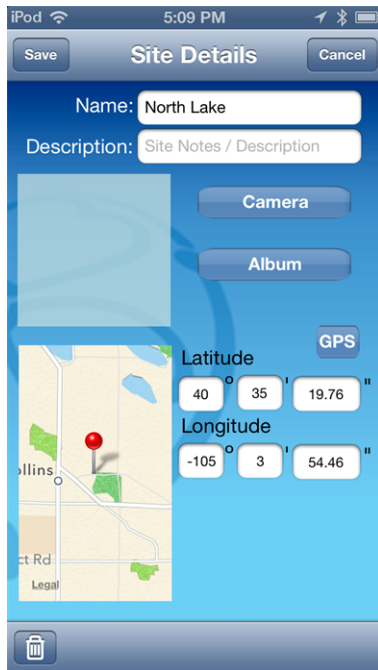

4. Tap the **Name** field. Type the name for the new site and tap **Return**.
5. To add a description, tap the **Description** field. Type a description and tap **Return**. A description is optional.
6. To take a site photo, tap the **Camera** button, tap the camera icon to take a new photo, tap the **Use** button. A site photo is optional.
7. To select an existing photo, tap the **Album** button, tap **Camera Roll**, tap an existing photo.
8. To locate your site with Maps or GPS, tap the **GPS** button and your current location is automatically associated with the site. You can also enter GPS coordinates, or tap and hold on the map to select a location.



Location Services must be turned on for an accurate location to display on the map. See **Settings > Location and Security**.

9. Tap the **Save** button.
10. Tap the **Set** button next to the site you created. Now you are ready to record data associated with the selected site.

## Select a Site

After a site has been created, you can select it to record data that will be associated with that site.

1. From the Live Readings screen, tap the **Sites** button.
2. Locate the site with which you want to associate your data.

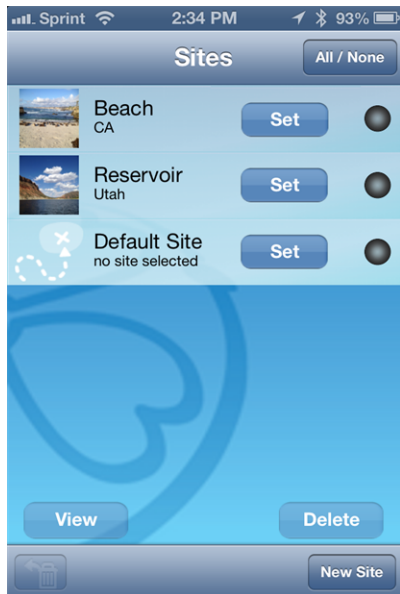

3. Tap the **Set** button. The site will appear on the Live Readings screen and recorded data will be associated with the selected site.

## Edit a Site

1. Tap the **Sites** button.
2. Locate the site you intend to edit.
3. Tap the **circle** next to the **Select** button for the site.
4. Tap the **View** button, and make changes to the site information.
5. Tap the **Save** button.

## Delete a Site

1. Tap the **Sites** button.
2. Locate the site you intend to delete.
3. Tap the **circle** associated with the site.
4. Tap the **Delete** button.



This procedure sends the site to the trash where you can choose to completely delete it, or restore the site. You cannot delete the default site.

## Restore a Site

1. It is possible to restore a deleted site.
2. From the **Home** screen, tap the **Sites** button.
3. Tap the **Restore From Garbage Can** icon.



4. Tap the site you intend to restore.
5. Tap the **Restore** button.

## *iSitu Data*

### **About Data**

iSitu allows you to view real-time readings, record readings in ten-second intervals, email data, store data to the mobile device, and transfer data from the mobile device to a PC.

### **Salinity Value in Data Log**

The iSitu App allows you to manually set a salinity value to match the body of water in which you are taking dissolved oxygen measurements. This setting is accessed in the Calibration screen. The salinity value will appear in the logged data.

1. Tap the **Calibration** icon and select **Salinity**.

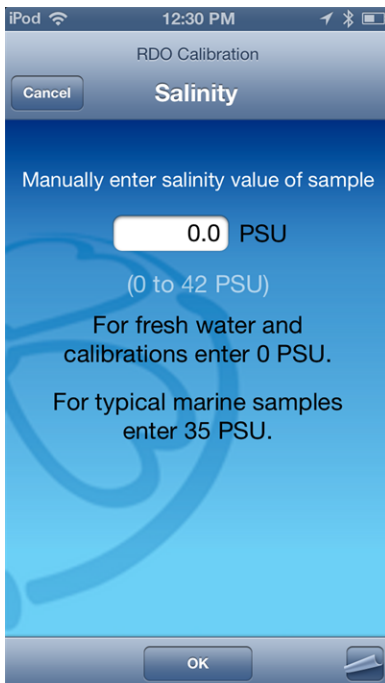

2. Tap in the field next to **PSU** and enter a salinity value.
3. Tap the **OK** button.



**This value does not clear automatically.** You must manually change the salinity value when you intend to take measurements in a different body of water and before you calibrate the instrument.

---

## Record Data

1. Tap the **Record** button on the **Live Readings** screen to record data. The number on the stopwatch icon represents how many 10-second data intervals have transpired.

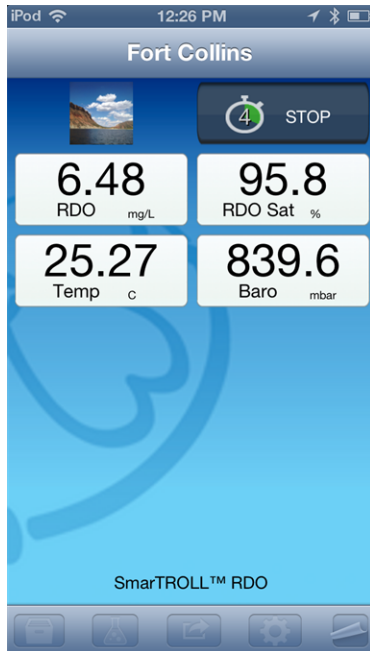

2. To stop recording, tap **Stop**.
3. Now you can email the data or download it to a computer.

## View an Individual Reading

Recorded data is stored on the Apple device in a comma-separated value (CSV) file and can be viewed in a spreadsheet format after the file has been emailed from the mobile device, or transferred to a computer via iTunes.

1. To view an individual reading, tap the **Action** icon.

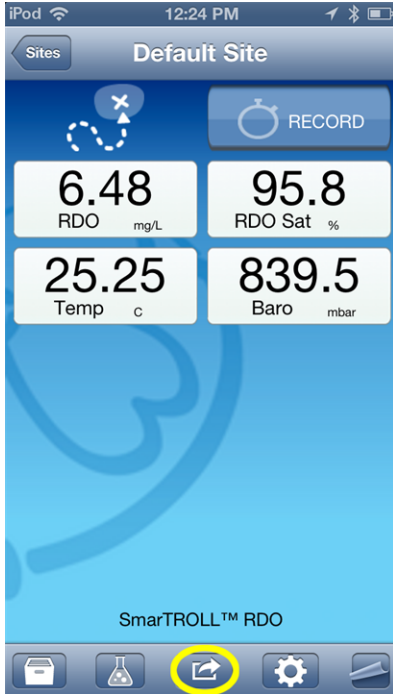

2. Tap **View Last Reading**.

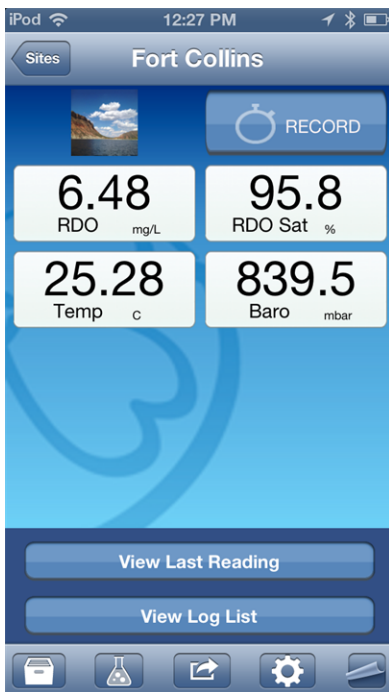



- 
- The most recent data in the last ten-second interval appears. Tap the **Home** icon to return to the **Live Readings** screen or tap the **Envelope** icon to email the data.



## Fort Collins

at 2013-06-03 12:27:18

<i>Parameter</i>	<i>Value</i>	<i>Unit</i>	<i>Quality</i>
Baro	839.5	mbar	OK: Normal
Temp	25.28	C	OK: Normal
RDO	6.48	mg/L	OK: Normal
RDO Sat	95.7	%	OK: Normal
Air Temp	27.40	C	OK: Normal



---

## View and Email Data from the Selected Site

After you have recorded data, you can email the data as a CSV file that can be opened with common spreadsheet software. Make sure the email feature is enabled on the mobile device.



See **Settings > Mail, Contacts, Calendars > Add Account**. You must also have connection to WiFi or cell phone service if you are using an iPhone®. See **Settings > Wi-Fi**.

1. Tap the **Action** icon.

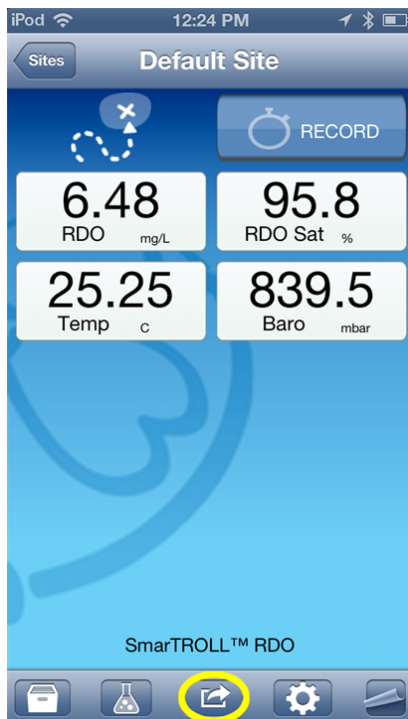

2. Tap **View Log List**. This shows a list for only the selected site.

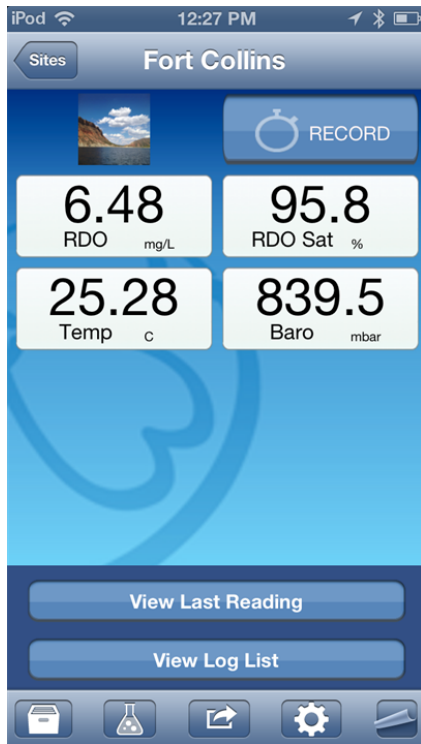

3. To select all logs in the list, tap the **All/None** button, or to select individual logs, tap them separately.

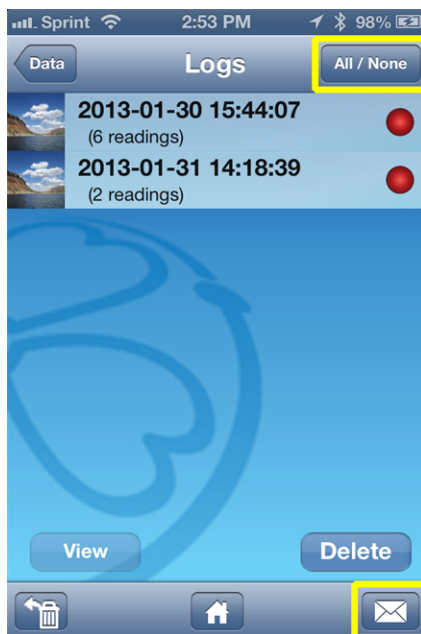

4. Tap the **Envelope** icon.
5. An email form appears with the logs that were selected attached.

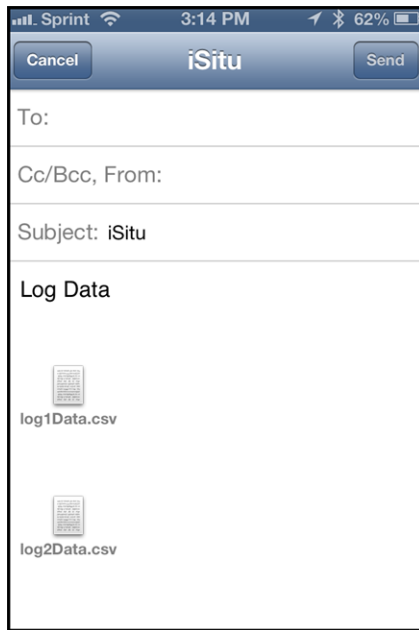

6. Enter an email address in the **To:** field.
7. Tap the **Send** button.



You can also transfer data to a computer using iTunes.

---

## View, Email, or Delete Data from Any Site

After you have recorded data, you can email the data as a CSV file that can be opened with common spreadsheet software. Make sure the email feature is enabled on the mobile device. See **Settings > Mail, Contacts, Calendars > Add Account**. You must also have connection to WiFi. See **Settings > Wi-Fi**.

1. Tap the **Data** icon.

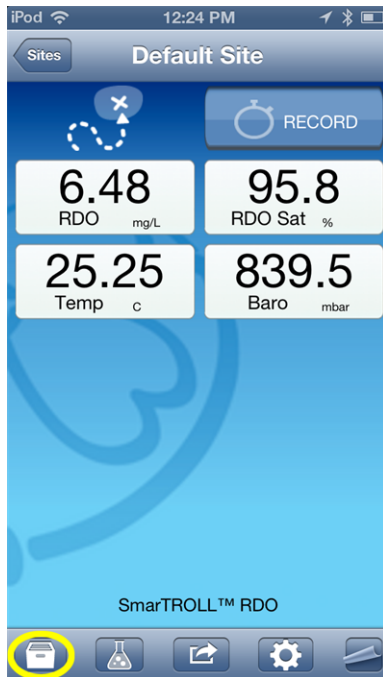

2. The Data screen displays a list of sites and the number of data logs within each site. Tap the site that contains the data you want to view, email or delete. The selection circle turns red and the **View**, and **Delete**, buttons become active.

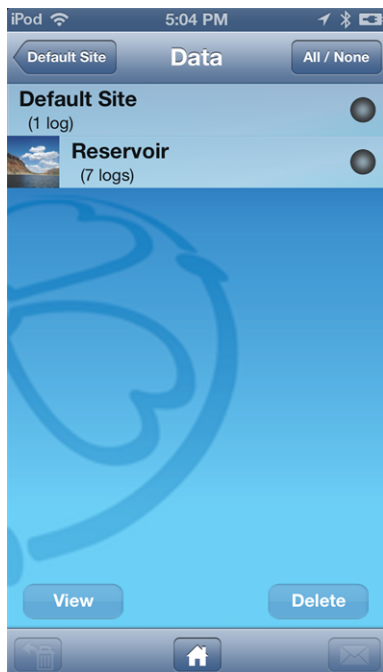

3. Tap the **View** button.
4. The list of logs associated with that site appears. Tap the log you want to view. The selection circle turns red and the **View** and **Delete** buttons become active. The **Envelope** icon also becomes active. You can select any of these options.

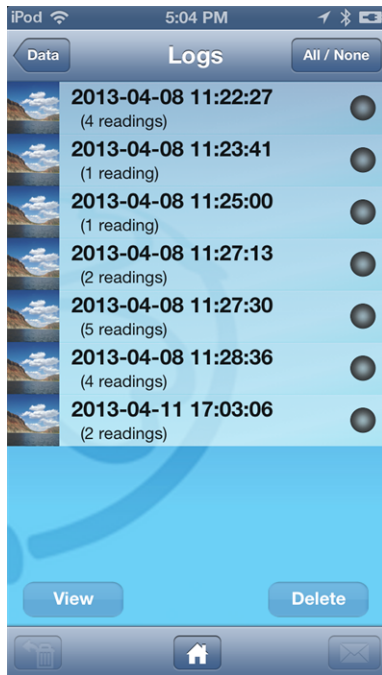

5. Tap the **View** button.
6. The list of readings within the log appears. Tap the reading you want to view. The selection circle turns red and the **View** button becomes active.
7. Tap the **View** button. The data for an individual reading appears.



## Fort Collins

at 2013-06-03 12:27:18

<i>Parameter</i>	<i>Value</i>	<i>Unit</i>	<i>Quality</i>
Baro	839.5	mbar	OK: Normal
Temp	25.28	C	OK: Normal
RDO	6.48	mg/L	OK: Normal
RDO Sat	95.7	%	OK: Normal
Air Temp	27.40	C	OK: Normal



---

## Emailing Data From Different Screens in iSitu

### Emailing from the Data screen

Select one or more sites and email all logs associated with the selected sites.

### Emailing from the Logs screen

Select one or more logs (from a single site) and email the selected logs.

### Emailing from the Readings screen

Select one or more readings (from a single log) and email them as one file. The file name will be appended with the word "reading."

### Emailing from the Data Details screen

Emailing from the Data Details view will email all readings in that log

## Transfer Data to a Computer

1. Connect the mobile device to a computer with iTunes installed.
2. Click on the Apple device icon next to the eject button.

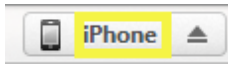

3. Click the word **Apps** near the top of the screen.
4. Scroll to the bottom of the screen and click on **iSitu**.
5. Click on a file and drag it to your desktop.



You can also email data to your computer.

---

## Delete all Logs by Site

1. Tap the **Data** icon.

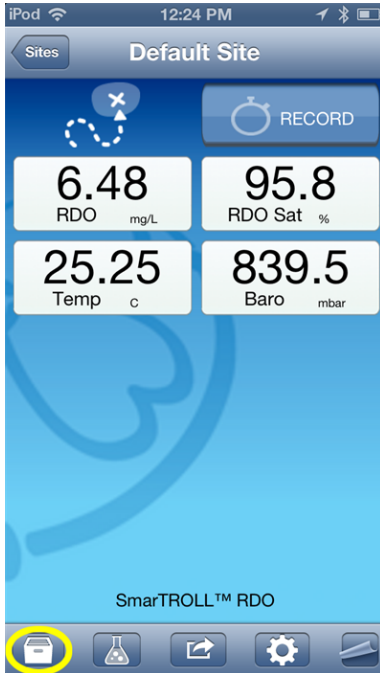

2. Tap the **All/None** button, or tap an individual site. The selection circle turns red when a site is selected.
3. Tap the **Delete** button. All logs associated with the site will be deleted.



This procedure sends the logs to the trash where you can choose to completely delete them or restore the logs.

## Restore Data

It is possible to restore deleted logs.

1. Tap the **Data** icon.
2. Tap the **Restore from Garbage Can** icon.



3. The contents of the Trash Can are displayed.
4. Tap the **All/None** button, or tap the individual logs you want to restore.
5. Tap the **Restore** button.



If you want to permanently delete data from the Trash Can, tap the **Delete** button.



### About Calibration

Tap the **Calibration** icon  in the iSitu App to access a list of methods by which to calibrate the RDO sensor.

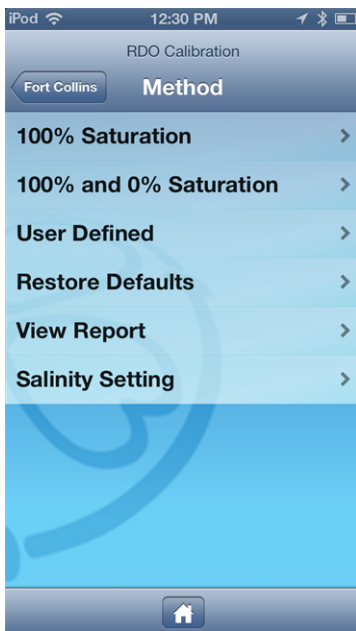

Note that the Salinity Setting in this list is not a calibration. It is a manual setting only. See page 22.

### Calibrate the Rugged Dissolved Oxygen Sensor

The RDO sensor requires very little maintenance. The zero oxygen calibration is optional.

1. Tap the **Calibration** icon .
2. Select the method by which you intend to calibrate the sensor. This example demonstrates a two-point calibration. Tap **100% and 0% Saturation**.

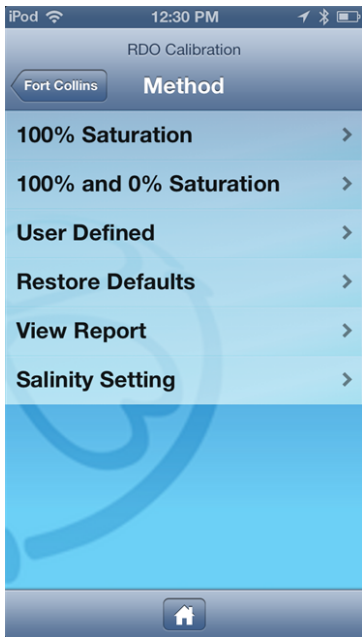

3. Place a water-saturated sponge in the bottom of the calibration cup. Place the instrument into the calibration cup, and tap **Start**.



The calibration cup must be vented to barometric pressure. Make sure the vented cap is installed.



4. When the calibration is stable, tap the **Accept** button.

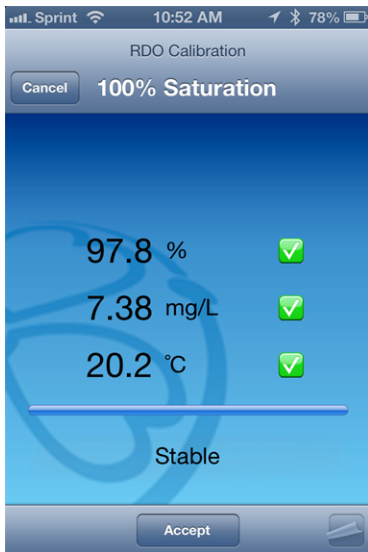

5. Remove the sponge and add fresh sodium sulfite solution to the fill line. Place the instrument into the calibration cup, and tap **Start**.



Do not allow the sensor to touch the bottom of the cup.

6. When the calibration is stable, tap the **Accept** button.

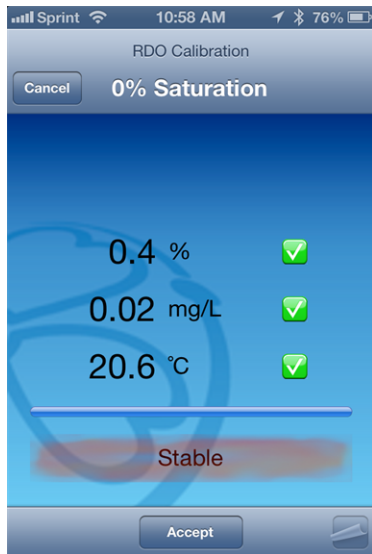

7. To view the calibration report, tap **View Report**.
8. Rinse the sensors thoroughly with DI water.

---

## Care and Maintenance

### Maintenance Schedule

For best results, send the instrument to the manufacturer for factory calibration every 12 to 18 months.

### User-Serviceable Parts

The user-serviceable parts on the instrument include the O-rings, and the RDO Sensor Cap.

### O-rings

The instrument has several O-rings that can be maintained by the user in order to keep moisture from entering the instrument and damaging the electronics. Apply a very thin layer of vacuum grease to new O-rings upon installation. The O-rings are located in the following areas.



1	Connector (1)
2	Instrument housing (1)
3	RDO Sensor Cap (2)

### RDO Fast Sensor Cap Replacement

The RDO Fast Sensor Cap has a 1-year typical life (15 months of total usage) after the sensor takes its first reading, or 36 months from the date of manufacture. Follow the instructions included in the RDO Sensor Cap Replacement Kit. Replacement caps are available from In-Situ Inc. or your authorized In-Situ distributor.

### Cleaning the RDO Sensor

#### Clean the Sensor Cap

1. Leave the cap on the sensor.
2. Rinse the sensor with clean water from a squirt bottle or spray bottle.
3. Gently wipe with a soft cloth or brush if biofouling is present.

- 
4. If extensive fouling or mineral build-up is present, soak the RDO Cap end (while the cap is still installed on the sensor) in commercially available household vinegar for 15 minutes, then soak in deionized water for 15 minutes.
  5. Do not use organic solvents because they will damage the sensing material. Do not remove the cap from the sensor prior to wiping.
  6. After cleaning the sensor cap, perform a 2-point calibration.

### **Clean the Optical Window**

1. Perform this task only once per year when you replace the sensor cap.
2. Pull to remove the sensor cap.
3. Gently wipe the optical window with the supplied lens wipe.



Important: Do not wet the interior lens area with water or any solution.