

Operator's Manual

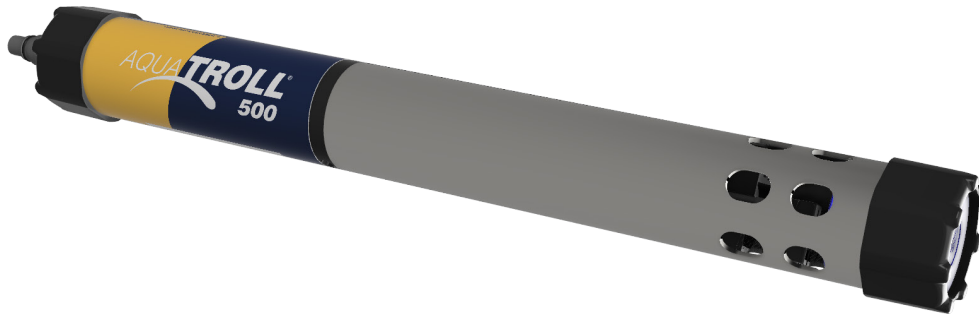

Contents

Instrument Overview	5
Serial Number Location	5
Unpacking and Inspection	5
Obtaining Repair Service	5
Guidelines for Cleaning Returned Equipment	6
Instrument Components	7
Required Accessories.....	8
Communication Device.....	8
Cable.....	8
Sensors	8
Software	9
Telemetry	9
Instrument Dimensions.....	10
LCD Screen	11
System Components	12
Base Unit Components	12
Accessories purchased separately	12
Cable.....	12
Calibration and Maintenance	13
Spot Checking Configuration.....	14
Getting Started (Spot-Checking)	15
Installing wiper motor and sensors.....	16
Handling pH and Ion-Selective Electrode Sensors (ISEs)	17
Using the RDO Sensor and RDO Fast Cap	17
Connecting the TROLL Com	18
Pairing the Instrument with the VuSitu Mobile App.....	18
Navigating VuSitu	19
Long-Press	20
Swipe Left	20
Swipe Right.....	20
Calibrating the sensors.....	21
Live Readings in VuSitu.....	23
Remote-Monitoring Configuration (Telemetry).....	25
Getting Started (Remote Monitoring).....	26
Configuring the Cube/Tube	27

Connecting to Win-Situ on a PC	28
Navigating the Win-Situ Interface	30
Connecting the Aqua TROLL 500 to a PLC or Data Logger.....	32
SDI-12 3 Wire	32
Modbus Master.....	33
Modbus Master with RS232 (Converter Required)	34
Modbus PLC Interface.....	35
Overview.....	35
Setting Up Instrument	35
Wiring the Modbus Master.....	35
Programming the PLC.....	35
Advanced Settings	36
Care and Maintenance.....	37
Maintenance Schedule	37
User-Serviceable Parts	37
O-rings	37
pH/ORP & ISE Sensor Replacement.....	37
RDO Sensor Cap Replacement.....	37
Instrument Storage	37
Cleaning the Sonde.....	38
Cleaning and Storing the pH/ORP Sensor	38
Replacing the Filling Solution	38
Replacing the Junction	38
Cleaning	39
Storage Recommendations	39
Cleaning and Storing the RDO Sensor	39
Storage	40
Cleaning and Storing the Conductivity Sensor	40
Cleaning and Storing the Turbidity Sensor	40
Instrument Specifications.....	41
Sensor Specifications	42
Potential Interferents.....	47
pH.....	47
Conductivity	47
Dissolved Oxygen.....	47
ORP.....	47
Ammonium.....	47
Chloride.....	47

Nitrate	47
Ammonium, Chloride and Nitrate Interferent Concentrations.....	47
Total Dissolved Solids	49
Dissolved Oxygen RDO Sensor Specifications	50
Level, Depth and Pressure Sensor Specifications.....	51
ORP Sensor Specifications	51
pH Sensor Specifications.....	51
Temperature Sensor Specifications.....	52
Turbidity Sensor Specifications	52
Total Suspended Solids.....	52
Ammonium Sensor Specifications	53
Ammonia (Un-ionized Ammonia and Total Ammonia)	53
Chloride Sensor Specifications	53
Nitrate Sensor Specifications.....	54
More Information	55
Appendix	56
Appendix A: Sensor Discovery	56
Appendix B: Parameter Numbers and Locations	56
Appendix C: Unit IDs.....	58
Appendix D: Register Data Formats	60

Instrument Overview

Serial Number Location

The instrument serial number is on the product label affixed to the instrument body. Serial numbers for individual sensors are engraved on the sensor body.

Unpacking and Inspection

Your equipment was carefully inspected before shipping. Check the equipment for any physical damage sustained during shipment. Notify In-Situ and file a claim with the carrier if there is any such damage; do not attempt to deploy or operate the instrument.

! Save packing materials for future storage and shipping of your equipment.

Obtaining Repair Service

If you suspect your system is malfunctioning and repair is needed, you can help assure efficient servicing by following these guidelines:

1. Call or email In-Situ Technical Support. Have the product model and serial number available.
2. Be prepared to describe the problem, including how the product was used and the conditions noted at the time of the malfunction.
3. If Technical Support determines that service is needed, they will ask your company to fill out the RMA form and pre-approve a specified monetary amount for repair charges. When the form and pre-approval is received,
4. Technical Support will assign an RMA (Return Material Authorization) number.
5. Clean the product as described in the manual.
6. If the product contains a removable battery, remove and retain it unless you are returning the system for a refund or Technical Support states otherwise.
7. Carefully pack your product in its original shipping box, if possible.
8. Mark the RMA number clearly on the outside of the box.
9. Send the package, shipping prepaid, to:

In-Situ
ATTN: Repairs
221 East Lincoln Avenue
Fort Collins, CO 80524

The warranty does not cover damage during transit. In-Situ recommends insurance for all shipments. Warranty repairs will be shipped back prepaid.

Outside the U.S.

Contact your international In-Situ distributor for repair and service information.

Guidelines for Cleaning Returned Equipment

Please help us protect the health and safety of our employees by cleaning and decontaminating equipment that has been subjected to potential biological or health hazards, and labeling such equipment. Unfortunately, we cannot service your equipment without such notification. Please complete and sign the form on page 12 (or a similar statement certifying that the equipment has been cleaned and decontaminated) and send it to us with each instrument.

- We recommend the glassware cleaning product, Alconox, available from In-Situ and from laboratory supply companies.
- Clean all cables and remove all foreign matter.
- Clean the cable connectors with a clean, dry cloth. Do not submerge the connectors.
- Clean the instrument including the nosecone, cable head, and protective caps.

I If an instrument is returned to our Service Center for repair or recalibration without a statement that it has been cleaned and decontaminated, or if it is the opinion of our Service Representatives that the equipment presents a potential health or biological hazard, we reserve the right to withhold service until proper certification is obtained.

Decontamination & Cleaning Statement

Company Name	Phone
Address	
City	State
Instrument Type	Serial Number
Contaminant(s) if known)	
Decontamination procedure(s) used	
Cleaning verified by	Title
Date	

Safety

- Do not submerge the Wireless TROLL Com or your mobile device in liquid.
- Ensure that sensors, or sensor plugs, are completely inserted into the ports, so that no liquid can enter the instrument.
- Ensure that the RDO Sensor Cap is pressed firmly over the sensor lens and is flush with the instrument before submerging in liquid.
- Replace the cable if insulation or connectors are damaged.
- Make sure the probe and sensor O-rings are clean and free of damage.

Instrument Components

Exploded View 1

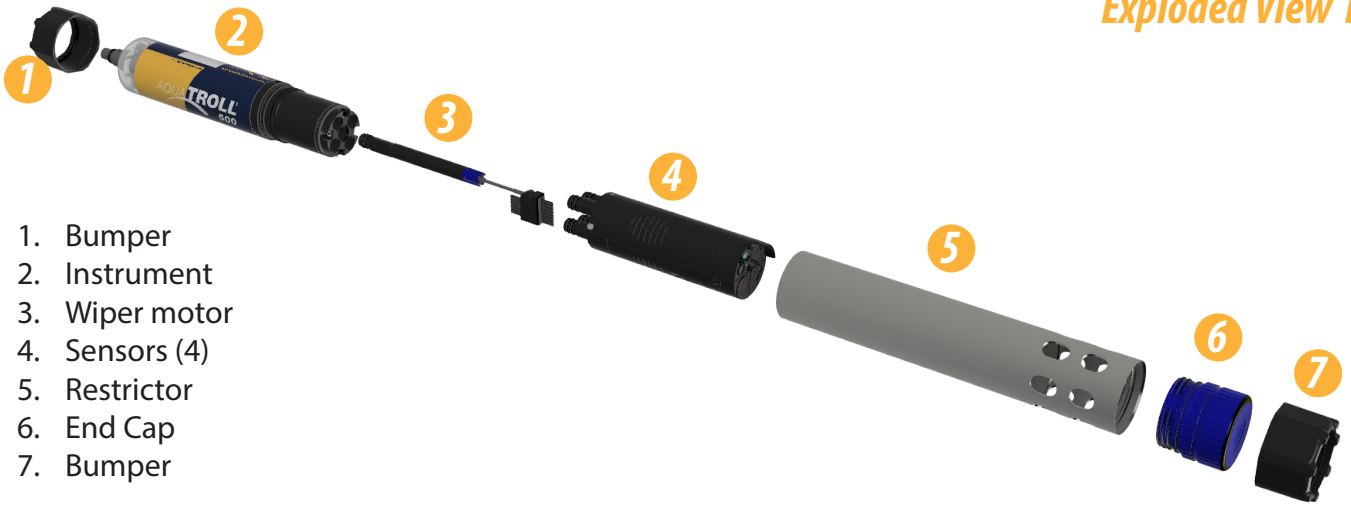

Exploded View 2



End View

Flat edge of connector aligns with flat edge of Rugged Cable.

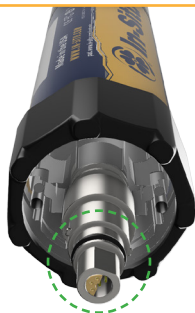

Sensor Port Detail

Sensor ports

Wiper motor port

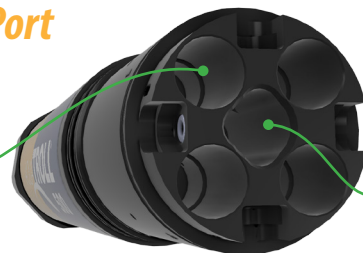

Required Accessories

Communication Device

You will need a communication device to calibrate, configure and deploy the Aqua TROLL 500.



Wireless TROLL Com

Provides power to the Aqua TROLL 500.

Configure and deploy with a Bluetooth-enabled Android device.

Connects the Aqua TROLL 500 to a PC via USB or Bluetooth.

Cable



Rugged Twist-Lock Cable

Connects the Aqua TROLL 500 to a Wireless TROLL Com, USB TROLL Com or Cube/Tube.

Vented or non-vented.

Sensors



Available Sensors

1. Temperature
2. Conductivity/temperature
3. pH/ORP
4. RDO
5. Turbidity
6. Ammonium
7. Chloride
8. Nitrate

Software



Win-Situ 5 Software for PC

Calibrate, configure and take readings with the Aqua TROLL 500 from a PC.



VuSitu Mobile App

Calibrate, configure and deploy the Aqua TROLL 500 from a Bluetooth-enabled Android device.

Download it from www.in-situ.com.

Get it at play.google.com.

Telemetry



Tube 300

Power Aqua TROLL 500 in remote-monitoring applications

Send data to HydroVu or another FTP server.

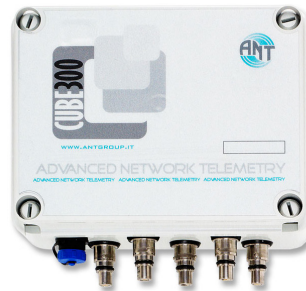

Cube 300

Power up to five instruments in remote-monitoring applications

Send data to HydroVu or another FTP server.

* Cubes and Tubes are available in battery or solar-powered options.

Instrument Dimensions



LCD Screen

! View instrument status and access settings via the LCD screen. The sonde must be connected to a Wireless TROLL Com or other power source.

Accessing the LCD Menu



LCD screen will display sensor status on activation.



Hold instrument horizontally and slowly tap Aqua TROLL 500 logo 3-4 times to view the main menu.



Tilt instrument left or right to scroll through menu options.



Select an item when its background turns black by tapping the instrument once.



You can enable Bluetooth communication directly with the sonde via the Bluetooth menu option.

Possible Port Statuses



Sensors installed



Port plugs installed



Sensor/port error

Possible Power Statuses



Power level within specs



Power level NOT within specs

Possible Connected Statuses



Connected via Bluetooth



Connected via cable

Error Messages



Install All Sensors!

Port(s) empty



RDO Cap expired!

Cap expiration

System Components

Base Unit Components

	Part Number
RDO Sensor	0063450
Combination pH/ORP Sensor	0063470
Turbidity	0063480
Combination Conductivity/Temperature Sensor or standalone Temperature Sensor	0063460, 0063490
Ammonium Sensor	0033700
Chloride Sensor	0033720
Nitrate Sensor	0033710
Dual Stainless Titanium Storage Chamber	0079880
Sensor Port Plug	0063510
Rubber Bumpers (2)	0079880
Wiper or Wiper Port Plug	0063500, 0064630

Accessories purchased separately

Wireless TROLL Com for Android	0031240
Rugged Android Tablet	0064860

Cable

Stripped-and-tinned Cable with male connector	0053310
Twist-Lock Bulkhead Connector	0053240
Cable Extender	0051490
Large Desiccant (titanium connector)	0051810
Large Desiccant (ABS connector)	0053550
Small Desiccant (3 pack) - storage desiccant	0052230
Desiccant Refill Kit for Large or Outboard Desiccant	0029140

Calibration and Maintenance

RDO X Cap Replacement Kit	0079790
RDO Fast Cap	0066800
pH/ORP & ISE Replacement Reference Junction Kit	0078990
Wiper Brush Kit	0079810
Maintenance Kit	0078940
Copper Antifouling Guard	0076100
Quick-Cal Solution for calibrating DO , Conductivity, pH and ORP	0033250
Dissolved Oxygen Calibration Kit	0032110
DO Field Calibration Kit	0080830
Conductivity Calibration Kit (Full)	0032090
Conductivity Calibration Kit (Low)	0032630
Conductivity Calibration Kit (High)	0032640
pH Calibration Kit	0032080
pH/ORP Calibration Kit	0032120
pH & ISE Storage Solution	0065370
Individual Calibration Solutions	See website
Ammonium Calibration Kit (includes 1 liter each: 14 ppm, 140 ppm, 1400 ppm, DI water)	0032140
Chloride Calibration Kit (includes 1 liter each: 35.5ppm, 355 ppm, 3545 ppm, DI water)	0032150
Nitrate Calibration Kit (includes 1 liter each: 14 ppm, 140 ppm, 1400 ppm, DI water)	0032130

Spot Checking Configuration

Take live readings with an Aqua TROLL 500, Rugged Cable, Wireless TROLL Com and a Bluetooth-enabled Android device.



Wireless TROLL Com

Powers the Aqua TROLL 500 during live readings.

Communicates with the VuSitu mobile app via Bluetooth.

Rugged Cable

Connects the Wireless TROLL Com to the instrument.

Aqua TROLL 500

Takes live readings and transfers data to the Wireless TROLL Com via the Rugged Cable.

Getting Started (Spot-Checking)

Follow the steps below to set up and deploy the Aqua TROLL 500 when you intend to take live readings. See the next page for information about setting up and using the instrument in remote-monitoring applications.

1 **Unpack instrument.**

Remove sonde, sensors and maintenance supplies from box.

2 **Install RDO cap and pH/ORP sensor.**

- a. If your instrument includes a pH/ORP sensor, you'll need to install it prior to calibration and deployment.
- b. Install the RDO cap on the RDO sensor.

3 **Download and install software.**

- PC users visit www.in-situ.com
- Mobile device users: play.google.com

4 **Connect instrument to TROLL Com.**

- a. Attach the Rugged Cable to the TROLL Com and Aqua TROLL 500.
- b. Press power button on TROLL Com and pair with the VuSitu mobile app.

5 **Calibrate.**

Perform a single or multi-point calibration.

6 **Configure the instrument and take readings.**

- a. Create a site in VuSitu.
- b. Take readings in VuSitu's Snapshot or Live Readings mode.
- c. Save readings and share via email, SMS or cloud storage.

Installing Wiper Motor and Sensors



Remove restrictor.



Install wiper motor.



Install sensors in any order.

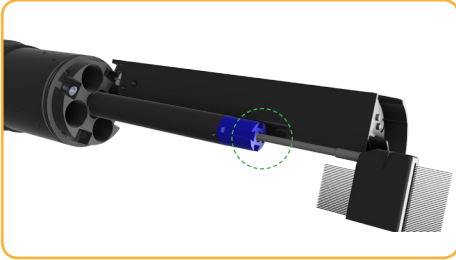

Align sensor with interlock groove in wiper motor.



Tighten set-screw at base of each sensor.



Unscrew end cap from restrictor.



Flip restrictor and install with restrictor holes near center of instrument for calibration.



Flip restrictor and replace end cap before deployment.

Handling pH and Ion-Selective Electrode Sensors (ISEs)

- ! Salt may accumulate around the reference junctions of the ammonium, chloride, nitrate and pH sensors. Rinse with deionized water to remove any buildup.



- ! Before using the pH or ISE sensors for the first time, replace the reference filling solution. Condition the sensors by soaking in calibration standard for 4-24 hours prior to deployment.

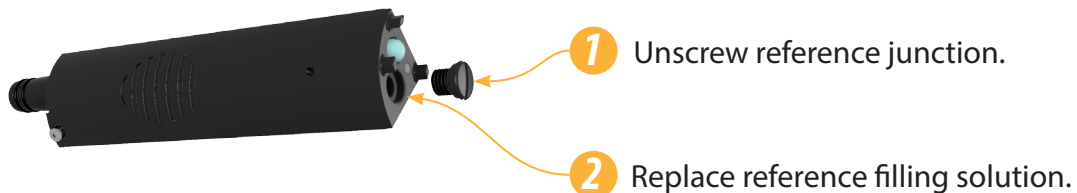

Using the RDO Sensor and RDO Fast Cap

- ! The wiper can severely reduce the life of the RDO Fast Cap. Wear will vary by application. Verify sensor performance prior to use and replace the Fast Cap if damaged.

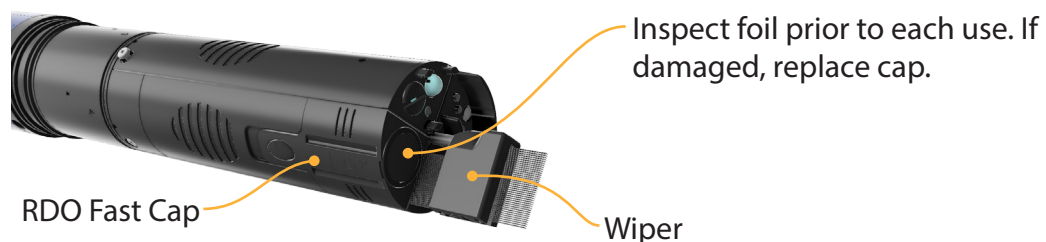

Connecting the TROLL Com

Wireless TROLL Com

- ! You must connect the Aqua TROLL 500 to a Wireless TROLL Com to calibrate the instrument, configure or take live readings.



Attach Rugged Cable to the Wireless TROLL Com.



Attach opposite end of cable to the Aqua TROLL 500.



Press power button.

Pairing the Instrument with the VuSitu Mobile App

- ! Download and install the VuSitu mobile app from the Google Play store. Visit play.google.com on your Android device.



Turn on the Wireless TROLL Com and open VuSitu mobile app.

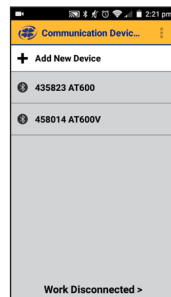

Select **Add New Device** when connecting for the first time.



Locate the serial number under the yellow lid on the Wireless TROLL Com.

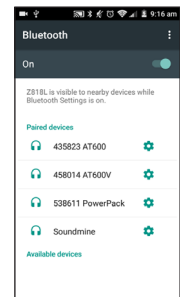

From device's Bluetooth Settings screen, tap serial number of Wireless TROLL COM.

Select **Choose or Add a Device**.

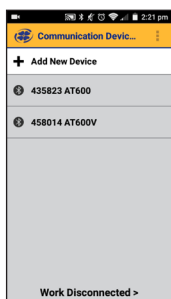

Tap mobile device's back button and tap serial number from list.

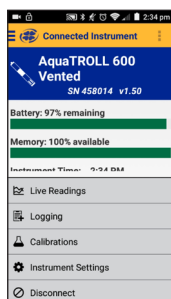

Tap mobile device's **Back** button to view Connected Instrument screen.

Navigating VuSitu

! After pairing a Wireless TROLL Com with VuSitu, the app will always display the Connected Instrument screen at launch. You can access all features of the app from this screen.

Connected Instrument Screen

The screenshot shows the 'Connected Instrument' screen for an Aqua TROLL 500. The top status bar shows the time as 4:27 PM. The app title is 'Connected Instrument'. Below the title, the instrument name 'Aqua TROLL 500' is displayed, along with its serial number 'SN 50002' and version 'v0.13'. The battery level is shown as 84% remaining. The instrument time is 4:27 PM on 1/15/2018. The bottom menu contains four items: 'Live Readings', 'Calibrations', 'Instrument Settings', and 'Disconnect'. Callout boxes provide the following descriptions:

- Access menu.** (points to the hamburger menu icon)
- Access help information.** (points to the three-dot menu icon)
- Take single readings or continuously record at two-second intervals.** (points to 'Live Readings')
- Calibrate sensors.** (points to 'Calibrations')
- Access instrument clock and telemetry settings.** (points to 'Instrument Settings')
- Disconnect app from instrument.** (points to 'Disconnect')

Selecting with Long-press and Swipe

Long-Press

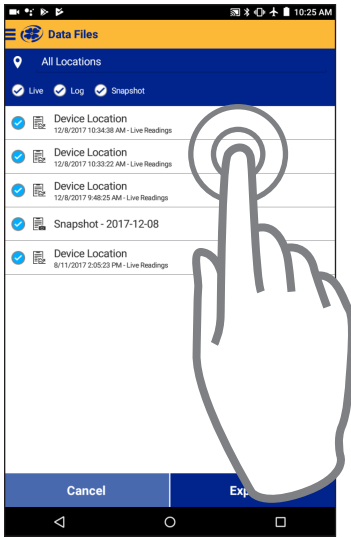

Press and hold any of the items in a list of files.

You can now select two or more items.

Swipe Left

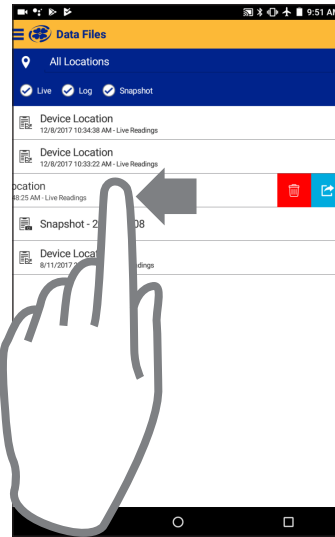

Press an item and swipe left to reveal the delete and sharing icons.

Swipe Right

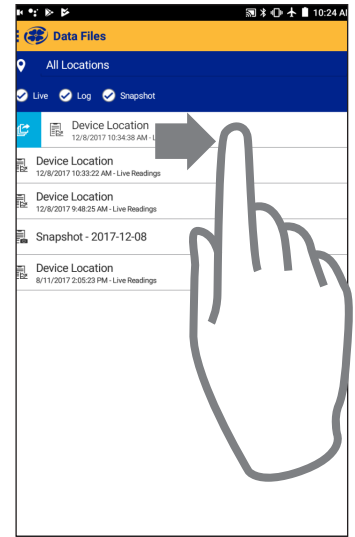

Press any item in a list and swipe right to reveal the sharing icon.

Calibrating the Sensors

Solution-based calibration

Use the solution-based procedure described below to calibrate all sensors except RDO. You will need the following items.

- Calibration standard, or multiple standards for multi-point calibrations
- Wireless TROLL Com connected to the Aqua TROLL 500
- Bluetooth-enabled Android device



Connect the sonde to a Wireless TROLL Com and pair with VuSitu.

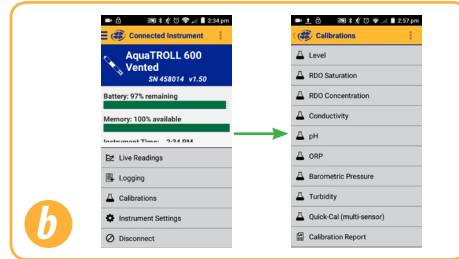

In VuSitu, click Calibrations from the Connected Instrument screen and choose sensor to calibrate.



Remove cap from instrument and pour 10–20 ml of DI water into restrictor.



Gently shake the sonde in a circular motion to rinse the inside of restrictor and sensors.



Discard the DI water and repeat rinsing procedure two more times with 10–20 ml of your first calibration standard.



Follow the instructions in VuSitu to perform the calibration.

RDO 100% Saturation Calibration: Water Saturated Air

Use the procedure below to calibrate the Aqua TROLL 500 RDO sensor, or see the next section for an alternative method.



Place the restrictor in calibration mode (holes near center of instrument).



Saturate a small sponge with water.



Place sponge in restrictor.



Reinstall the end cap and leave sponge in restrictor for five minutes.

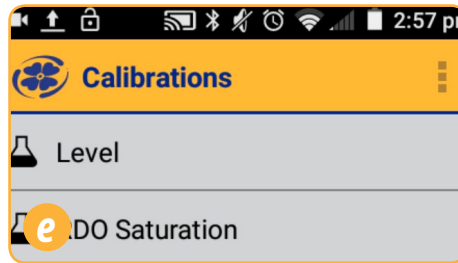

Follow the instructions in VuSitu to finish calibration.

RDO 100% Saturation Calibration: Saturation Bubbler

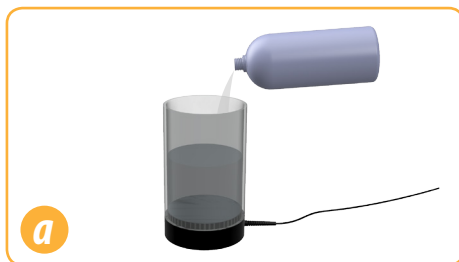

Fill a 100% saturation bubbler two-thirds with tap water.



Turn on bubbler and allow 5-10 minutes for 100% saturation.

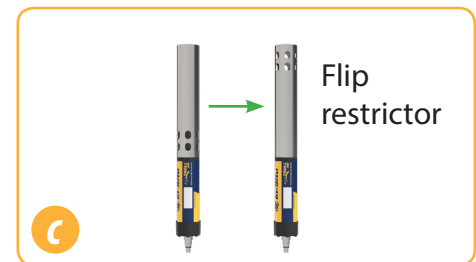

Put sonde into deployment mode by flipping restrictor 180 degrees.



Place sonde into bubbler.

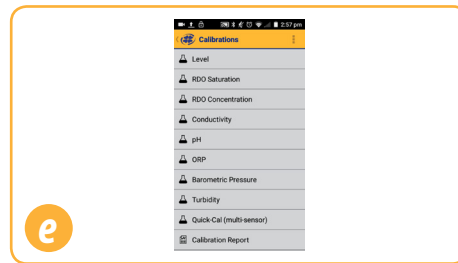

Open the VuSitu mobile app and tap Calibrations > RDO Saturation.

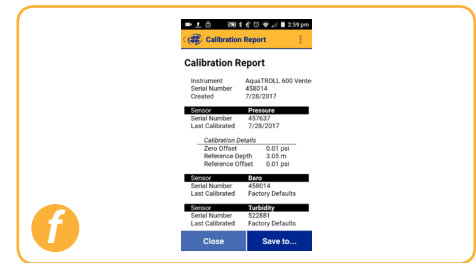

Follow instructions in VuSitu to finish calibration.

Live Readings in VuSitu

! To take live readings with the Aqua TROLL 500 and VuSitu mobile app, the sonde must be connected to a Wireless TROLL Com.

Snapshot Mode

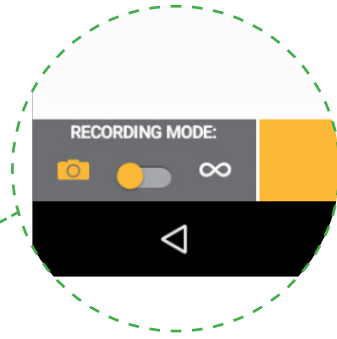
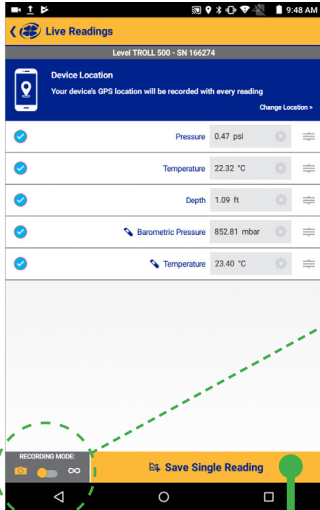

Take a single reading and save to Snapshot file.

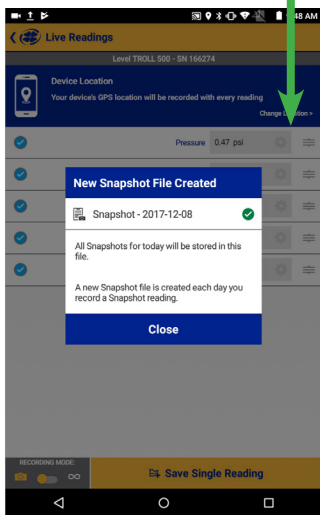

View Snapshot file from Menu > Data Files.

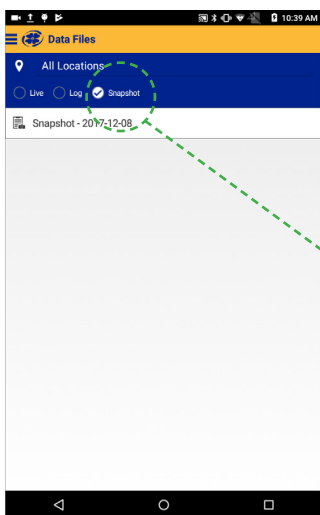

Check Snapshot option.

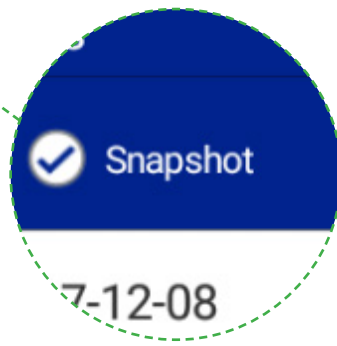

Live Readings Mode

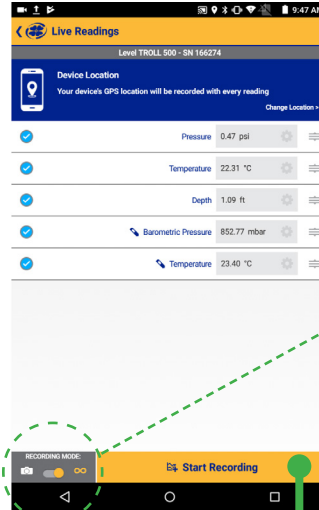

Take readings at two-second intervals.

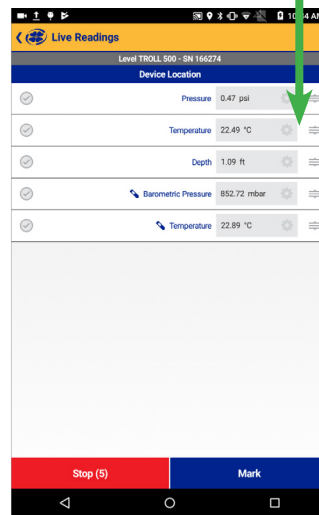

View file from Menu > Data Files.



Check Live option.



Exporting Data Files

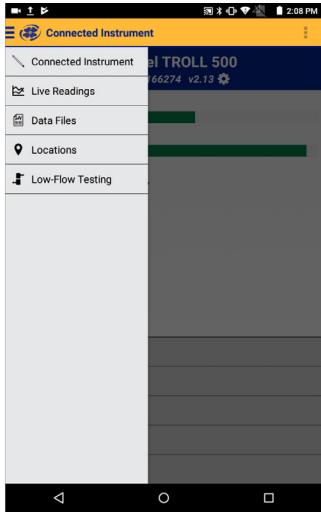

Use the menu at the top left to access the Data Files screen.

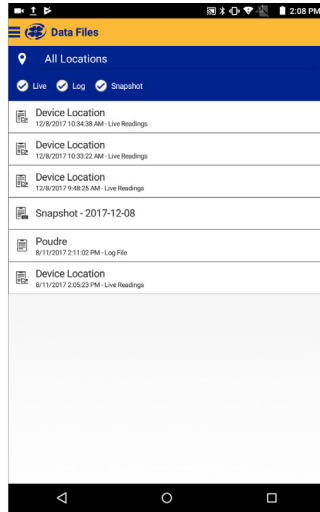

Tap one of the files to view and export.

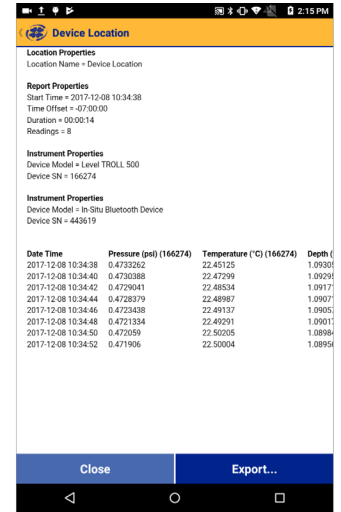

Tap **Export** to save the file and choose how you wish to share it.

Viewing Data Files

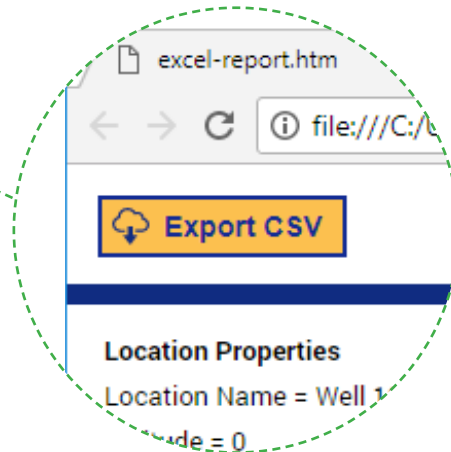
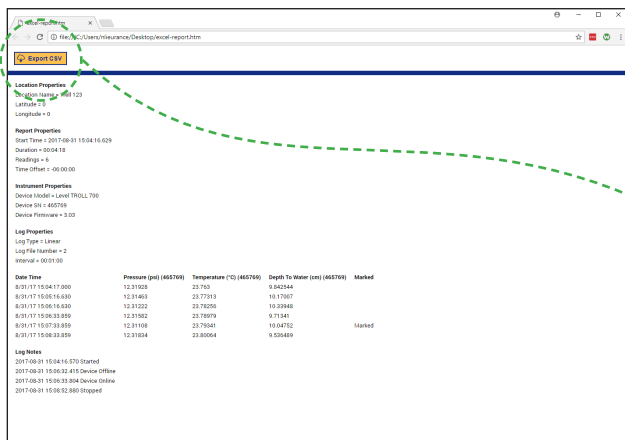

Open a VuSitu data file in any web browser. Click the button at the top left to generate a CSV.

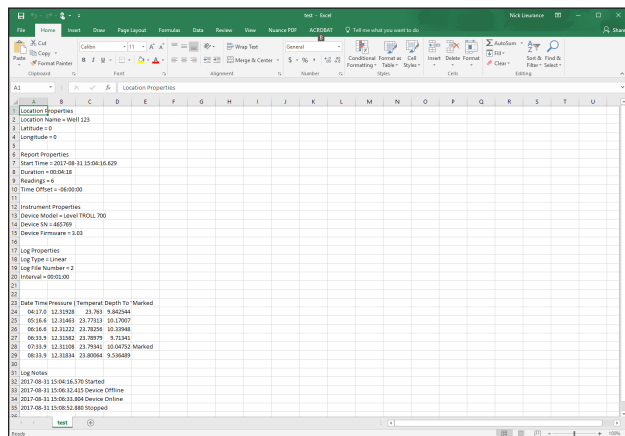

Remote-Monitoring Configuration (Telemetry)

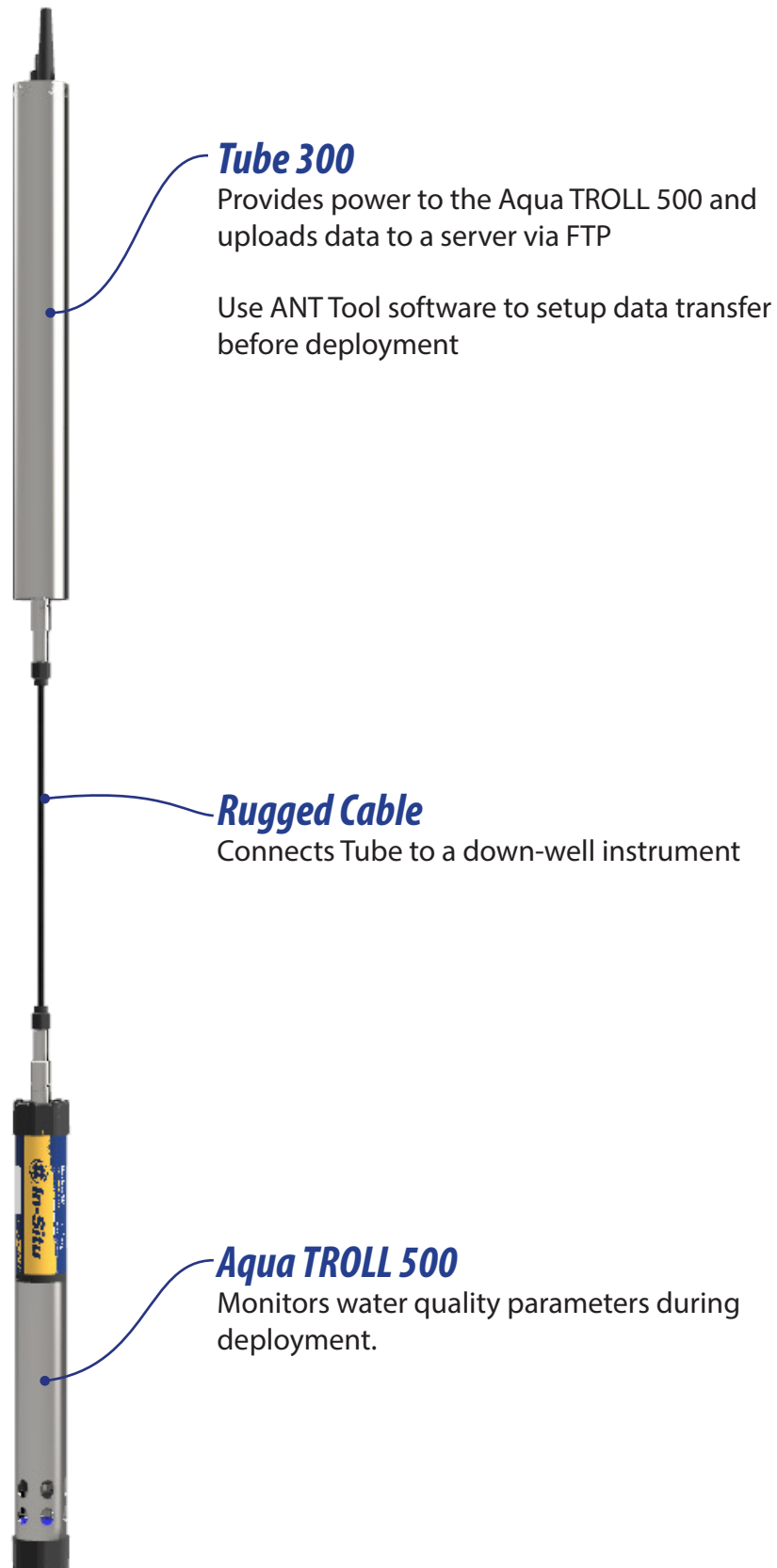

Getting Started (Remote Monitoring)

1 **Unpack instrument.**

Remove sonde, sensors and maintenance supplies from box.

2 **Install RDO cap and pH/ORP sensor.**

- a. If your instrument includes a pH/ORP sensor, you'll need to install it prior to calibration and deployment.
- b. Install the RDO cap on the RDO sensor.

3 **Download and install software.**

- PC users visit www.in-situ.com to download Win-Situ 5 and the ANT Tube/Cube Tool
- Mobile device users: play.google.com

4 **Connect instrument to TROLL Com.**

- a. Connect the Aqua TROLL 500 to a Wireless TROLL Com with a Rugged Cable.
- b. Press the power button on the Wireless TROLL Com.

5 **Calibrate.**

Perform a single or multi-point calibration.

6 **Configure.**

See instructions on the next page to configure the telemetry device.

7 **Configure the Tube/Cube.**

Use the ANT Cube/Tube tool to set alarms and FTP information.

8 **Deploy.**

Place the instrument in the deployment location.

Configuring the Cube/Tube

! Before deploying the Aqua TROLL 500 in a remote-monitoring application, configure the Tube/Cube and the sonde.

1 **Download and install the ANT Tool.**

Visit www.in-situ.com/software and download the ANT Tube/Cube Tool.

2 **Connect the Aqua TROLL 500 to your PC.**

Connect the Cube/Tube to a PC with the setup cable.

3 **Configure Cube/Tube options.**

Use the ANT Tool to configure alarms and FTP information.

4 **Deploy the instrument.**

Connect Cube/Tube to the instrument with a Rugged Cable.
Place the tube and instrument in the deployment location.

Connecting to Win-Situ on a PC

Connecting to Win-Situ via Bluetooth

- ! Download and install Win-Situ by visiting www.in-situ.com. The Wireless TROLL Com must be connected to the sonde and powered on to connect the instrument to Win-Situ.

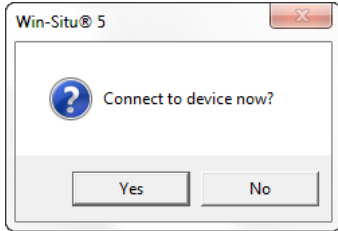

Open Win-Situ. Select **Yes** when asked to connect now.

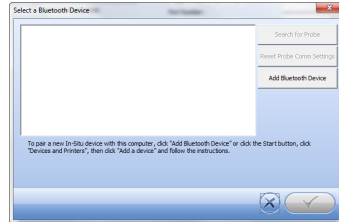

Click **Add Bluetooth Device** button.

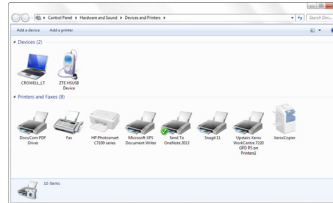

From Devices and Printers window, click **Add a device**.

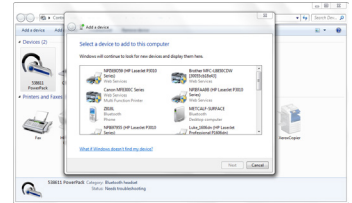

Select your Wireless TROLL Com (PowerPack) from the list of Bluetooth-enabled devices. Click **Next**.



Make sure device is highlighted in Select a Bluetooth Device window and click check mark button.

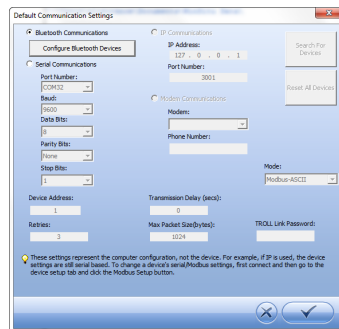

Click check mark button on Default Communication Settings window to close.



Click the yellow connect button at the bottom right of the screen.

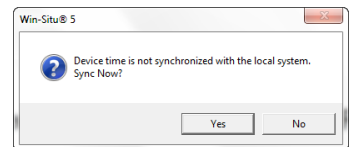

Click Yes if prompted to sync device time with local system.

Connecting to Win-Situ via USB

- ! You can connect a Wireless TROLL Com to a PC with the included USB cable. Plug the cable into the port at the top of the TROLL Com and the USB port on your PC.

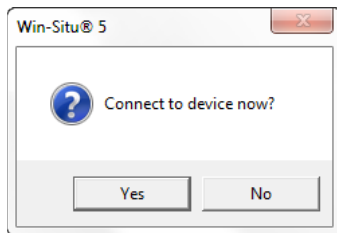
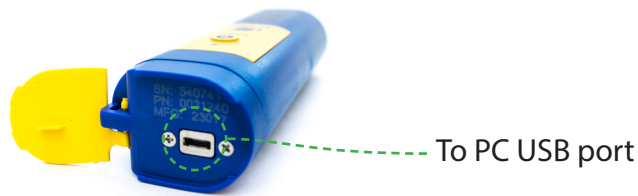

Open Win-Situ. Select **No** when asked to connect now.

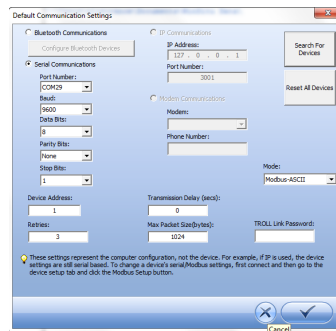

Click Preferences > Com Settings from menu bar and choose correct com port. Select Serial Communications button. Click check mark button.



Click the yellow connect button at the bottom right of the screen.

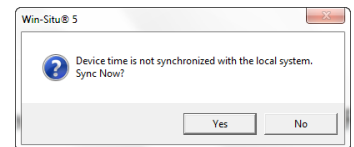

Click Yes if prompted to sync device time with local system.

Navigating the Win-Situ Interface

Home Tab



Display Sites list



View data files

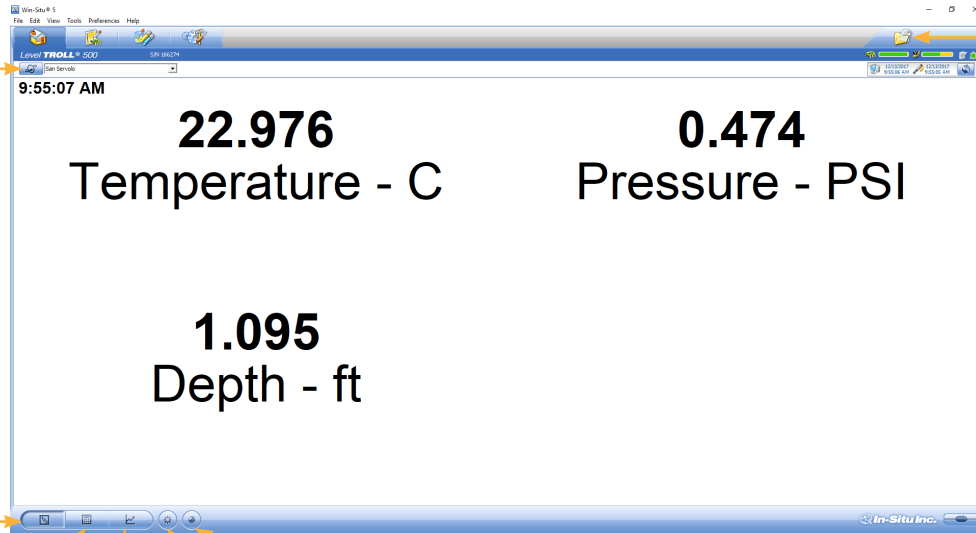

Meter view



List view



Graph view



Record snapshot



Record current values

Sensor Tab



Set up sensor (double-click)

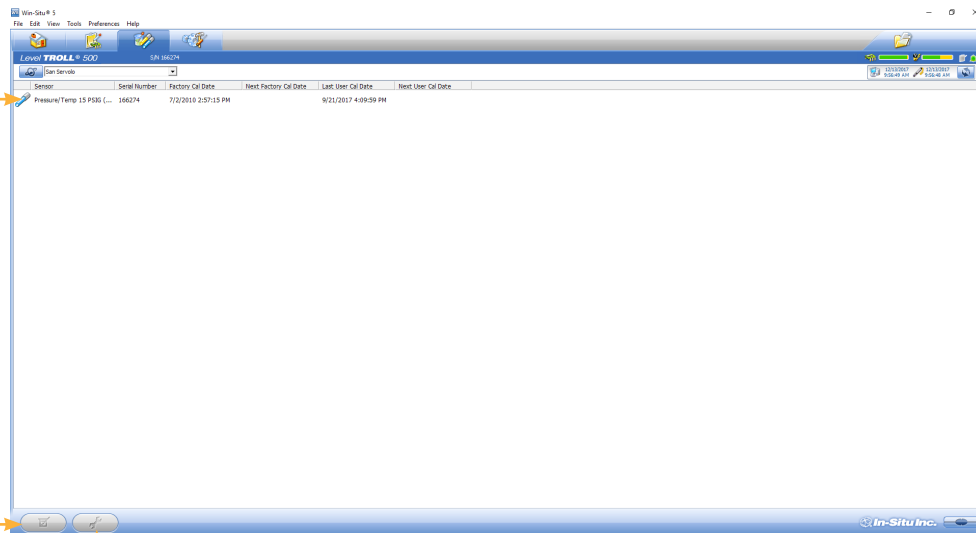

Calibrate sensor



Set up sensor

Device Setup Tab

The image displays the Win-Studio software interface for configuring a device. The main window shows the 'Device Setup' tab with various configuration options. Three dialog boxes are overlaid on the main window, each linked to a specific tab in the main interface by orange arrows:

- Analog Setup:** This dialog is linked to the 'Analog Setup...' tab. It features a 'Sensor' dropdown set to 'Pres(G) 35ft' and a 'Parameter' dropdown set to 'Pressure'. It includes two sections for scaling: 'Zero Scale (4mA)' with a 'Value' of 0 and 'Full Scale (20mA)' with a 'Value' of 15, both in PSI. At the bottom, there are radio buttons for 'Disable Analog Output' and 'Enable Analog Output'.
- SDI-12 Setup:** This dialog is linked to the 'SDI-12 Setup...' tab. It has an 'Address Character' field set to '0'. The 'Sensor' is 'Pres(G) 35ft' and the 'Parameter' is 'Pressure'. The 'Output Order' list contains two entries: 'Pres(G) 35ft - Pressure - PSI' and 'Pres(G) 35ft - Temperature - C'. A 'Remove' button and navigation arrows are at the bottom.
- Serial Communication Settings:** This dialog is linked to the 'Serial Setup...' tab. It shows a 'Device Address' of 1. The 'Serial Communications' section includes: Baud rate (19200), Data Bits (8), Parity Bits (Even), and Stop Bits (1). The 'End of Message Timeout (ms)' is 1000 and the 'End of Session Timeout (ms)' is 10000. The 'Mode' is set to 'Modbus-RTU'.

The background window shows the 'Device Information' tab with fields for Name, Manufacturer Date (3/20/10), Firmware Version (2.13), Hardware Version (3), and Serial Number (12010017). It also includes sections for Device Status, Power Management, and Device Firmware Update.

Connecting the Aqua TROLL 500 to a PLC or Data Logger

SDI-12 3 Wire

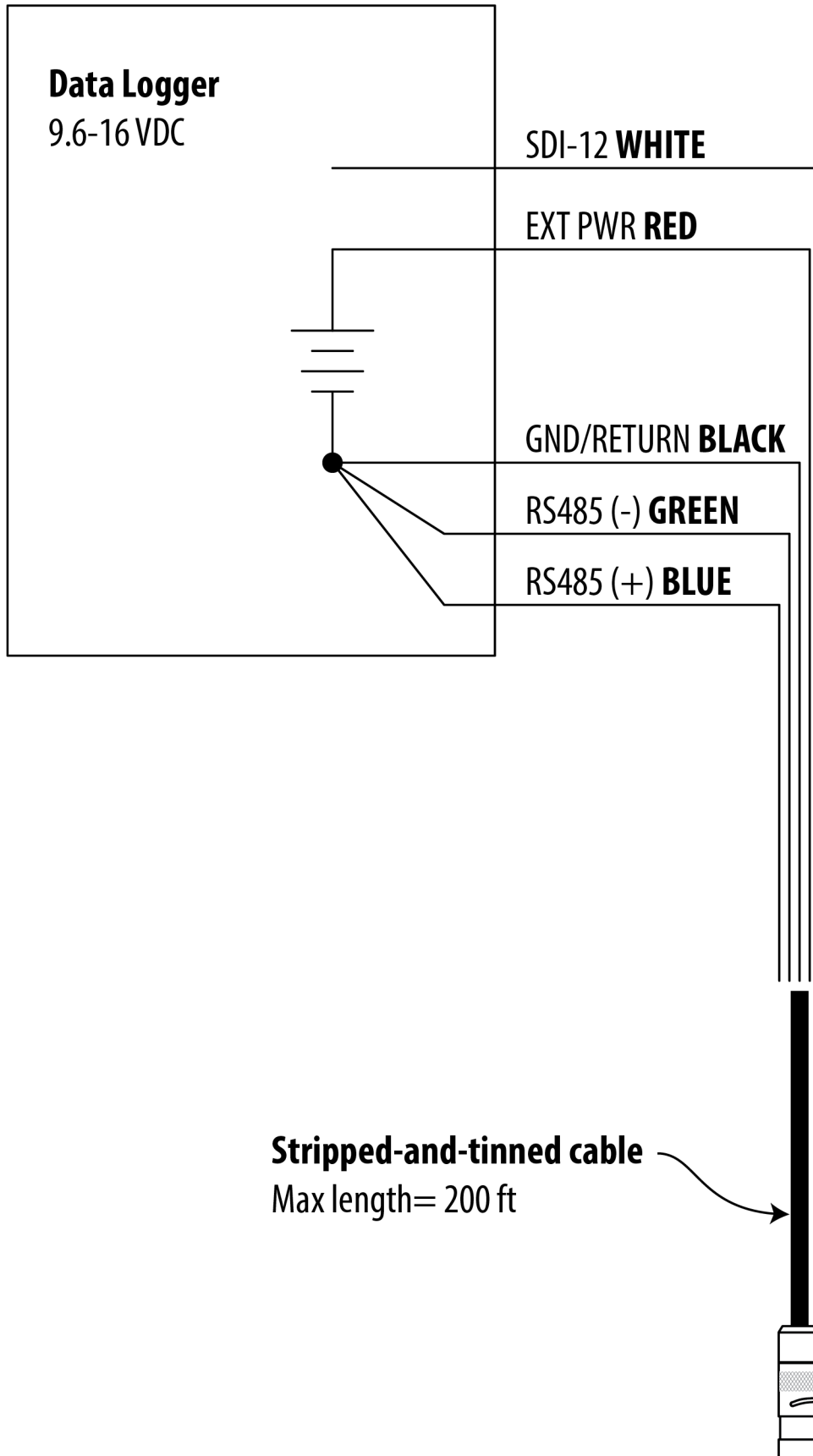

Modbus Master

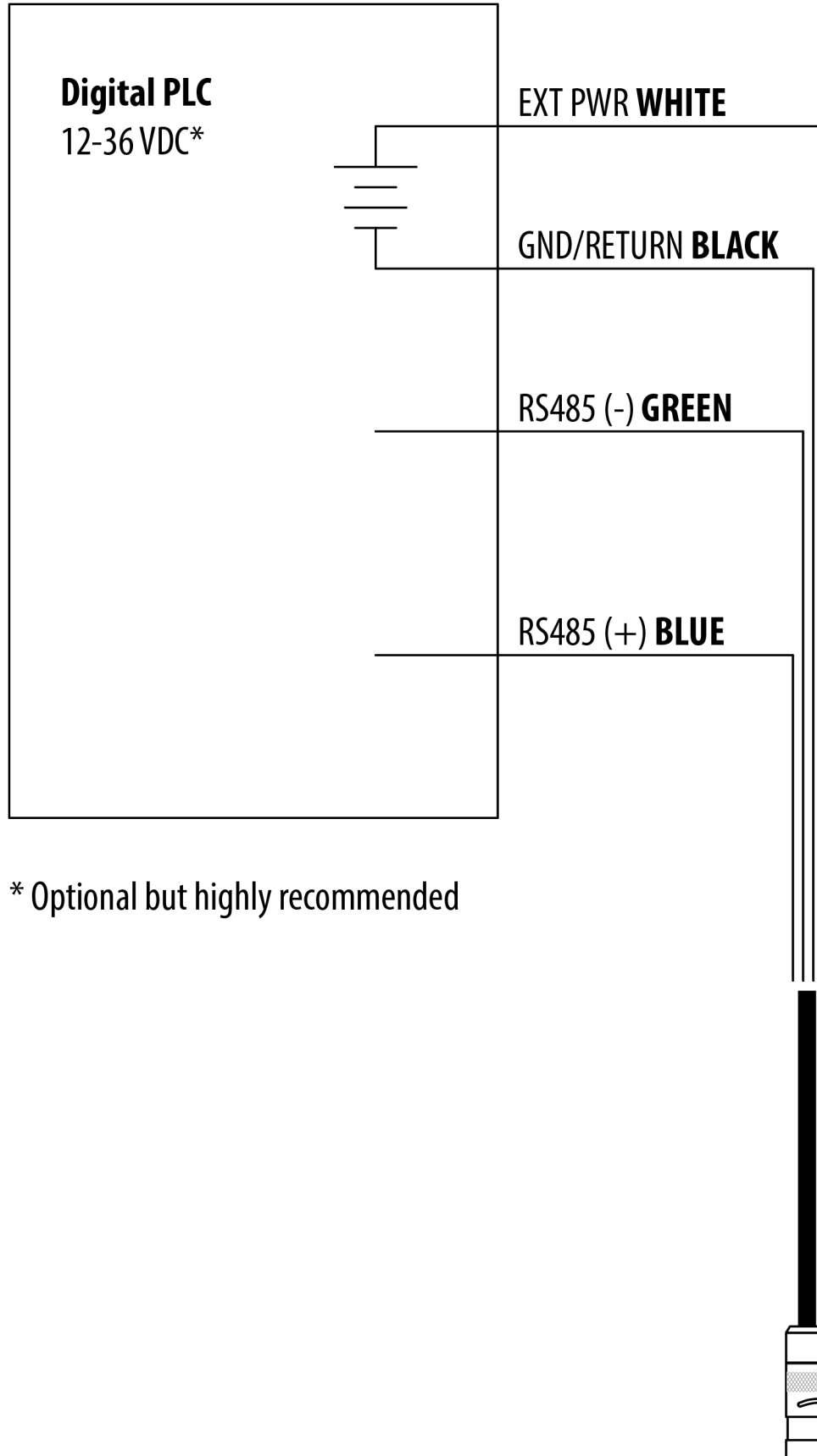

Modbus Master with RS232 (Converter Required)

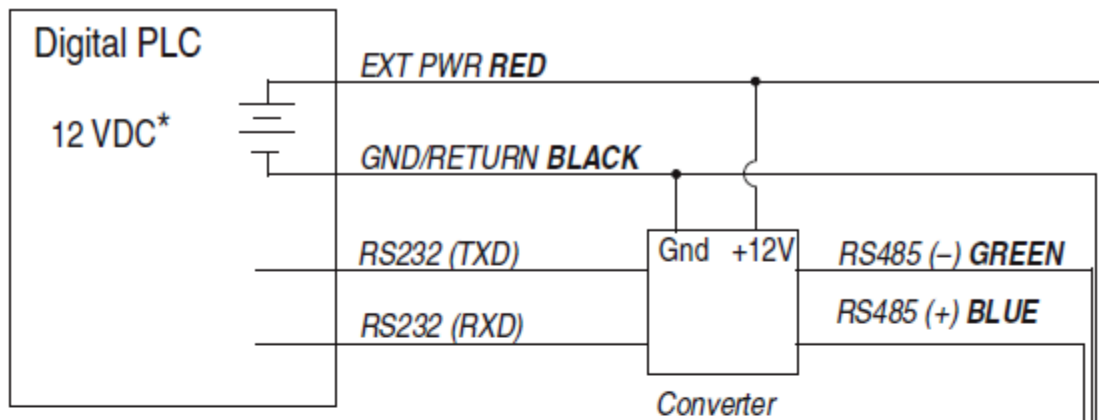

* Voltage limited by converter

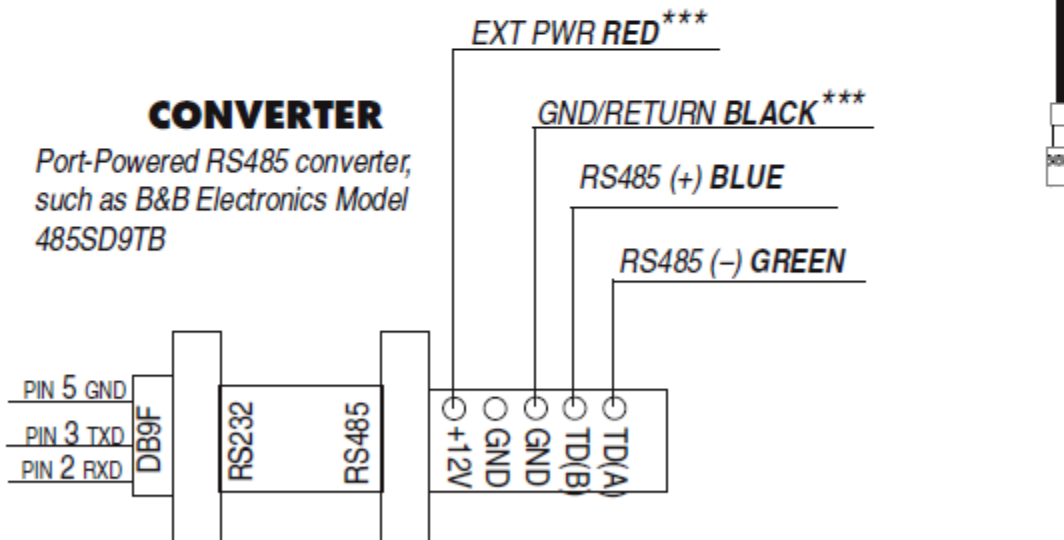

***Required if port power is not available

Modbus PLC Interface

Overview

The Modbus PLC Interface is a simplified method of communicating with the Aqua TROLL 500 using the Modbus protocol. It reduces programming complexity and allows the user to remove sensors and reinstall them in different ports. Please observe the following limitations when using this interface:

- Only one sensor of any sensor model can be used in the sonde (for example: only one turbidity sensor can be installed).
- If a parameter is provided by more than one of the installed sensors, the interface will return the first value available.
- Firmware version 1.71 or later must be installed on the sonde.

For information about the full Modbus capabilities of your sonde, see the Aqua TROLL 500/600 Interface Specification at www.in-situ.com/support/type/documentation.

Setting Up Instrument

1. Install the sensors and turn on the display by holding the instrument vertically.
 - a. Ensure the display turns on and check the LCD to ensure the sensors are working.
2. The setup below is using the instrument's factory default settings. Use WinSitu or VuSitu to reset the instrument to factory defaults if they have been changed.
 - a. Take note of any changes in default units setup.

Wiring the Modbus Master

Connect the Twist-Lock termination to the instrument and wire the stripped-and-tinned connection as shown below:

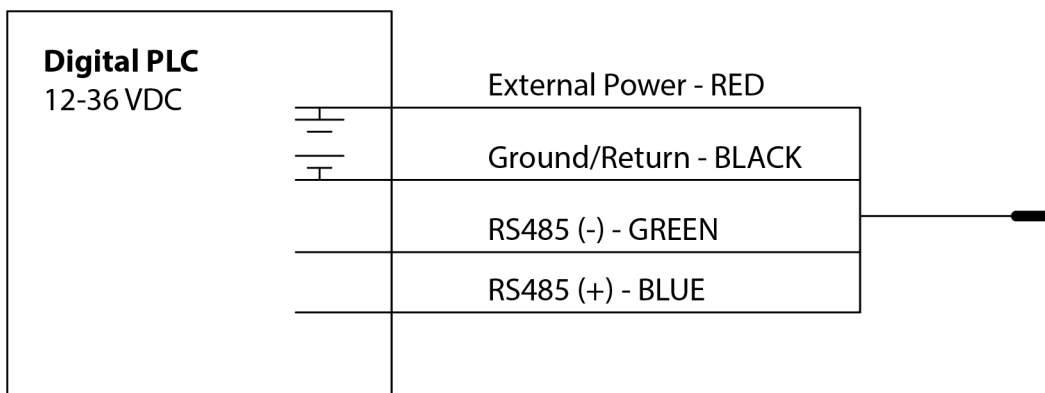

Programming the PLC

1. Setup the serial communication the following values:

Mode	Start Bit	Baud Rate	Data Bits	Parity	Stop Bit
RTU	1	19200	8	Even	1

2. Set the device address to: 1
3. Set the PLC to wake-up the device by sending any Modbus command.
 - a. This could be a carriage return, reading the slave id or reading any register.
4. Read the discovery register using Appendix A to trigger the instrument to scan the sensors.
 - a. The return value can be discarded.
 - b. Each register is a holding register. Some PLCs require you to add 40000 to the register number or address. For example: 9301 would be 49301.
 - c. Alternatively, you can prompt the instrument to discover its sensor mapping by connecting it to the VuSitu mobile app or Win-Situ software.
5. Select the register to read on the PLC using Appendix B
 - a. Some PLC devices use the register number directly in programming statements, others use register addresses, which are one less than the register number; the programmer must adhere to the PLC's programming style
 - b. Each register is a holding register. Some PLCs require you to add 40000 to the register number or address. For example: 5451 would be 45451.
6. Set the type of register to: 32-bit float
 - a. If asked by the PLC this is 2 registers
7. Set the byte order to: Big Endean (MSB)
 - a. This should be the default and may not be configurable on all PLCs

Advanced Settings

In addition to the measured value there is other information that can be read about the parameter through this interface. Using the offset from the base register for the parameter the following information can be read or written to the device.

Register Offset	Size (Registers)	Mode & Access Level (R/W)	Data Type	Description
0	2	R	float	The measured value from sensor
2	1	R	ushort	Data Quality Id: If this is 0 then there are no errors or warnings. See: Full System Specification
3	1	R/W	float	Units Id for the measured value. The default values are listed in the table below.
4	1	R	ushort	Parameter Id: The ID of the parameter for this location. See: Full System Specification
5	2	R/W	float	Off line sentinel value: The value that's returned on error or if the parameter isn't available. The default sentinel is 0.0

Care and Maintenance

Maintenance Schedule

For best results, send the instrument to the manufacturer for factory calibration every 12 to 18 months.

User-Serviceable Parts

The user-serviceable parts on the instrument include the O-rings, removable sensors, RDO Sensor Cap and pH/ORP/ISE reference junction filling solution.

O-rings

The instrument has several O-rings that can be maintained by the user in order to keep moisture from entering the instrument and damaging the electronics. Apply a very thin layer of vacuum grease to new O-rings upon installation. Check O-rings for cracks, chips, or discoloration and change when any of these conditions appear.

pH/ORP & ISE Sensor Replacement

To replace the pH/ORP or ISE sensor or to refill the reference junction, follow the instructions in the Instruction Sheet that is included with the replacement sensor.

RDO Sensor Cap Replacement

The RDO-X Sensor Cap has a 2-year typical life. The RDO Fast Cap has a 1-year typical life. Follow the instructions included in the RDO Sensor Cap Replacement Kit. Replacement caps are available from In-Situ Inc. or your authorized In-Situ distributor.

Instrument Storage

Short-term Storage (less than one week)



Place the restrictor in storage mode and pour ~15 mL of water, pH 4 buffer or pH/ISE storage solution over the sensors.

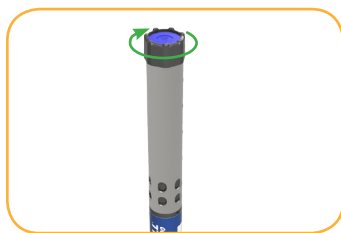

Screw the end cap onto the restrictor.

- ! pH/ORP sensor must remain wet during storage. ISE sensors may be stored dry but must be reconditioned prior to calibration and deployment.
-

Long-term Storage (more than one week)

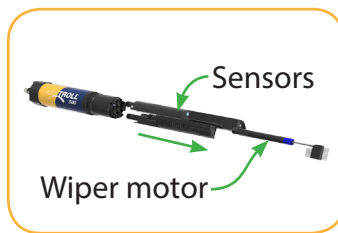

Remove the restrictor, sensors and wiper motor.



Thread the restrictor back onto the sonde with the holes at the center of the instrument.



Add a small amount of pH storage solution or pH 4 calibration standard to the sponge inside sensor cap.



Replace caps at both ends of sensor. Use electrical tape to seal the cap onto the sensor to prevent leaks or the sponge drying out.

Cleaning the Sonde

Rinse the sonde thoroughly, clean with warm water and mild soap, then rinse the sonde again. Allow to air dry. Be sure not to allow water to enter into the connector.

Cleaning and Storing the pH/ORP Sensor

If the ORP platinum electrode is dull or dirty, it can be cleaned with a swab and methanol or isopropyl alcohol. Rub the electrode gently until it is shiny.

The pH sensor must be kept moist for the life of the sensor. The sensor fill solution has a shelf life of 2 years. Replace the fill solution every 5 to 6 months or when:

- The sensor fails to calibrate within the acceptable slope and offset range.
- Sensor readings vary.
- Readings during calibration at pH 7 are greater than +30 mV or less than -30 mV.
- Sensor is slow to respond.



If the sensor fails to calibrate after you replace the fill solution, replace the reference junction.

Replacing the Filling Solution

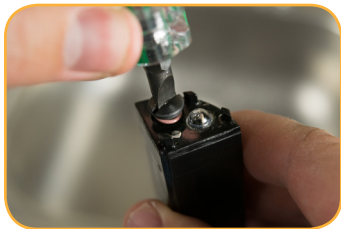

Remove sensor from sonde and unscrew reference junction.



Discard old solution.



Insert tube from filling solution bottle into sensor.



Squeeze solution into reservoir until full. Slowly remove tube.



Reinstall reference junction and wipe sensor body dry.



Soak sensor in tap water for at least 15 minutes.



If necessary, thoroughly clean the sensor connector to remove filling solution: Using a disposable pipette, fill the connector with isopropyl alcohol (70% to 100%), Shake to dry. Repeat 3 times. Dry overnight. When thoroughly dry, calibrate the sensor.

Replacing the Junction

Replace the junction when the sensor fails to calibrate with a reasonable slope and offset, even after you have replaced the filling solution.

- Unscrew the reference junction and discard.
- Replace the filling solution and screw in a new reference junction.
- Soak for 15 minutes, then calibrate the sensor.



Keep the junction damp at all times to avoid a lengthy rewetting process.

Cleaning

Begin with the most gentle cleaning method and continue to the other methods only if necessary. Do not directly wipe the glass bulb.

To clean the pH sensor, gently rinse with cold water. If further cleaning is required, consider the nature of the debris.

To remove crystalline deposits:

- Clean the sensor with warm water and mild soap.
- Soak the sensor in 5% HCl solution for 10 to 30 minutes.
- If deposits persist, alternate soaking in 5% HCl and 5% NaOH solutions.

To remove oily or greasy residue:

- Clean the sensor with warm water and mild soap.
- Methanol or isopropyl alcohol may be used for short soaking periods, up to 1 hour.
- Do not soak the sensor in strong solvents, such as chlorinated solvents, ethers, or ketones, such as acetone.

To remove protein-like material, or slimy film:

- Clean the sensor with warm water and mild soap.
- Soak the sensor in 0.1 M HCl solution for 10 minutes and then rinse with deionized water.

After performing any of these cleaning methods, rinse the sensor with water, then soak overnight in pH 4 buffer.

! After performing any of these cleaning methods, rinse the sensor with water, then soak overnight in pH 4 buffer.

Storage Recommendations

Prior to using the pH sensor after long-term storage, rinse the sensor with DI water and then soak it in pH 4 buffer for 1 or 2 hours. This will saturate the glass bulb with hydrogen ions and prepare it for use.

! Do not store the pH sensor in DI water because it will deplete the reference solution and drastically reduce the life of the sensor.

Cleaning and Storing the RDO Sensor

Routine Maintenance

1. Leave the sensor cap on.
2. Rinse the sensor with clean water.
3. Gently wipe with a soft cloth or brush if biofouling is present.
4. If extensive fouling or mineral buildup is present, soak the sensor in vinegar for 15 minutes, then soak in deionized water for 15 minutes.

! Do not use organic solvents—they will damage the sensor cap. Do not remove the sensor cap when rinsing or brushing.

6. After cleaning the sensor, perform a 2-point calibration.

Cleaning the optical window

1. Remove the cap.
2. Gently wipe the sensing window with the supplied lens cloth.

! Do not wet the lens with any liquid.

Storage

Prior to installation, store the sensor body and cap in the factory supplied containers.

Once installed on the sonde, the RDO sensor can be stored wet or dry depending on the sensor configuration of the sonde.

- ! Never store the RDO sensor without the sensor cap once it has been installed on the sonde.

Cleaning and Storing the Conductivity Sensor

Cleaning

Begin with the most gentle cleaning method and continue to the other methods only if necessary.

To clean the conductivity sensor face, gently rinse with clean, cold water. If further cleaning is required, consider the nature of the debris.

To remove crystalline deposits:

- Clean the sensor face with warm water and mild soap.
- Use a soft brush to gently clean the sensor pins and temperature button. Ensure removal of all debris around the base of the pins and button.
- If crystalline deposits persist, soak in 5% HCl for 10 to 30 minutes followed by warm soapy water and soft brushing.
- If deposits persist, alternate soaking in 5% HCl and 5% NaOH solutions followed by warm soapy water and soft brushing.

To remove oily or greasy residue:

- Clean the sensor face with warm water and mild soap.
- Using a soft brush, gently clean the sensor pins and temperature button. Ensure removal of all residue around the base of the pins and temperature button.
- Isopropyl alcohol may be used for short soaking periods, up to one hour.
- Do not soak in strong solvents such as chlorinated solvents, ethers or ketones (such as acetone).

To remove protein-like material, or slimy film:

- Clean the sensor face with warm water and mild soap.
- Using a soft brush, gently clean the sensor pins and temperature button. Ensure removal of all material/film around the base of the pins and temperature button.
- Soak the sensor in 0.10% HCl for 10 minutes and then rinse thoroughly with distilled water.

Storage

Prior to installation, store the sensor in the factory supplied container.

Once installed on the sonde, the Temperature Sensor and Conductivity Sensor can be stored wet or dry depending on the sensor configuration of the sonde. For the best accuracy over instrument life, keep the conductivity cell submersed in water for 24-48 hours prior to calibration and deployment.

Cleaning and Storing the Turbidity Sensor

Routine Maintenance

The optical windows should be clear of foreign material. To clear material gently rub the sensing windows using clean water and a soft cloth or swab. Do not use solvents on the sensor.

Storage

Prior to installation, store the sensor in the factory supplied container. Once installed on the sonde, the turbidity sensor can be stored wet or dry depending on the sensor configuration of the sonde.

Instrument Specifications

Operating temperature	-5° to 50° C (23° to 122° F)
Storage temperature	Components without fluid: -40° to 65° C (-40° to 149°F) pH/ORP probes: -5° to 65°C
Dimensions	Length: 46 cm (18.145") (includes connector) Diameter: 4.7 cm (1.860") With bail: 59cm (23.25")
Weight	0.978kg / 2.15 lbs. (includes instrument, sensors, restrictor and bumpers)
Wetted materials (sonde and sensors)	PC, PC alloy, Delrin, Santoprene, Inconel, Viton, Titanium, Platinum, Ceramic, Nylon, PVC, Graphite
Environmental rating	IP68 with all sensors and cable attached. IP67 with sensors removed, battery cover removed, or cable detached
Max pressure rating	Up to 150 PSI Ammonium/Nitrate up to 30PSI
Communication	RS485/MODBUS, Wireless TROLL Com, Bluetooth®
Reading rate	1 reading every 2 seconds
LCD screen	Integrated display shows status of sonde, sensor ports, power voltage and connectivity. BlueTooth may be disabled through the hidden menu
External power voltage External power current ¹	8-36 VDC (required for normal operation) Sleep: < 0.2 mA typical Measurement: 40 mA typical, 75 mA Max
Interface	Win-Situ 5 Software, VuSitu Mobile App on select mobile devices using Android 4.4 with Bluetooth 2.0
Cable	Vented or non-vented polyurethane or vented Tefzel®
Hex screw driver	0.050 in. (1.3 mm)
Software	Android: VuSitu through Google Play Windows: Win-Situ 5 Data Services: HydroVu
Interface	Android 4.4, requires BlueTooth 2.0
Certifications	CE, FCC, WEEE, RoHS Compliant

Sensor Specifications

Sensor	Shelf Life	Field Life	Recommended Calibration Frequency	Pressure Rating - PSI	Usable Depth Meters Feet		Operational Temperature Range
pH/ORP	15 months	1 year or greater	10 to 12 weeks	350	200	650	-5° to 50° C
RDO	NA	2 years or greater	12 months	350	200	650	-5° to 50° C
Conductivity	NA	2 years or greater	User calibration only if needed	350	200	650	-5° to 50° C
Temperature	NA	2 years or greater	NA	350	200	650	-5° to 50° C
Turbidity	NA	2 years or greater	User calibration only if needed	350	200	650	-5° to 50° C
Pressure	NA	2 years or greater	User calibration only if needed	12.8 42.7 108 285	9 30 76 200	30 100 250 650	-5° to 50° C
Barometric Pressure	NA	2 years or greater	User calibration only if needed	NA	NA	NA	-5° to 50° C
Ammonium	6 months	6 to 12 months	Monthly	30	25	70	0° to 40° C
Chloride	6 months	1 year or greater	Monthly	350	200	650	0° to 40° C
Nitrate	6 months	6 to 12 months	Monthly	30	25	70	0° to 40° C

Accuracy, Range & Resolution

Temperature ²	Accuracy	+/- 0.1° C
	Range	-5 to 50° C (23 to 122° F)
	Resolution/Precision	0.01° C
	Response Time	T63<2s, T90<15s, T95<30s
	Units of Measure	Celsius or Fahrenheit
	Method	EPA 170.1
Barometric Pressure (vented models only)	Accuracy	+/- 1.0 mBars
	Range	300 - 1100 mBars
	Resolution/Precision	0.1 mBar
	Response Time	T63<1s, T90<1s, T95<1s
	Units of Measure	Pressure: psi, kPa, bar, mbar, inHg, mmHg;
	Method	Silicon strain gauge
pH ³	Accuracy	±0.1 pH unit or better
	Range	0-14 pH
	Resolution/Precision	0.01 pH
	Response Time	T63<3s, T90<15s, T95<30s
	Units of Measure	pH, mV
	Method	Std. Methods 4500-H+, EPA 150.2
ORP ⁴	Accuracy	+/- 5 mV
	Range	±1400 mV
	Resolution/Precision	0.1 mV
	Response Time	T63<3s, T90<15s, T95<30s
	Units of Measure	mV
	Method	Std. Methods 2580

Conductivity ⁵	Accuracy	+/-0.5% of reading plus 1 µS/cm from 0 to 100,000 µS/cm; +/-1.0% of reading from 100,000 to 200,000 µS
	Range	0 to 350,000µS/cm 0-350 ppt 0-350 PSU
	Resolution/Precision	0.1 µS/cm 0.1 ppt 0.1 PSU
	Response Time	T63<1s, T90<3s, T95<5s
	Units of Measure	Actual conductivity (µS/cm, mS/cm); Specific conductivity (µS/cm, mS/cm); Salinity (PSU, ppt); Total dissolved solids (ppt, ppm); Resistivity (Ohms-cm); Density (g/cm ³)
	Method	Std. Methods 2510, EPA 120.1 Std. Methods 2520A
Rugged Dissolved Oxygen ⁶	Accuracy	±0.1mg/L +/-0.2mg/L +/-10% of reading
	Range	0 to 8 mg/L 8 to 20 mg/L 20 to 50 mg/L
	Resolution/Precision	0.01 mg/L
	Response Time	RDO-X: T63<15s, T90<45s, T95<60s Fast Cap: T63<15s, T90<45s, T95<60s
	Units of Measure	mg/L, %saturation, ppm
	Method	EPA-approved In-Situ Methods: 1002-8-2009, 1003-8-2009, 1004-8-2009
Turbidity ⁷	Accuracy	+/-2% of reading or +/-2 NTU, FNU, w.i.g.
	Range	0 – 4,000 NTU 0-1500 mg/L
	Resolution/Precision	0.01 NTU (0-1000); 0.1 NTU (1000-4000) 0.1 mg/L
	Response Time	T63<1s, T90<1s, T95<1s
	Units of Measure	NTU, FNU ppt, mg/L
	Method	ISO 7027
Ammonium ^{8,9}	Accuracy	±10% or ± 2mg/L, w.i.g.*
	Range	0-10,000 mg/L as N
	Resolution/Precision	0.01mg/L
	Response Time	T63<1s, T90<10s, T95<30s
	Units of Measure	mg/L, ppm, mV
	Method	

Unionized Ammonia, Total Ammonia	Accuracy	
	Range	0-10,000 mg/L as N
	Resolution/Precision	0.01mg/L
	Response Time	-
	Units of Measure	mg/L, ppm
	Method	-
Nitrate ⁸	Accuracy	±10% or ± 2mg/L, w.i.g.*
	Range	0-40,000 mg/L as N
	Resolution/Precision	0.01mg/L
	Response Time	T63<1s, T90<1s, T95<1s
	Units of Measure	mg/L, ppm, mV
	Method	Std. Methods 4500-NO3 D
Chloride ⁸	Accuracy	±10% or ± 2mg/L, w.i.g.*
	Range	0-150,000 mg/L - Cl-
	Resolution/Precision	0.01mg/L
	Response Time	T63<1s, T90<10s, T95<30s
	Units of Measure	mg/L, ppm, mV
	Method	Std. Methods 4500-Cl- D
Pressure ¹⁰	Accuracy	±0.1% full scale (FS)
	Range	Non-Vented or Vented 9.0 m (30 ft.) - Burst: 27 m (90 ft.) 30 m (100 ft.) - Burst: 40 m (130 ft.) 76 m (250 ft.) - Burst: 107 m (350 ft.) 100 m (325 ft.) - Burst: 200 m (650 ft.)
	Resolution/Precision	0.01% full scale
	Response Time	T63<1s, T90<1s, T95<1s
	Units of Measure	Pressure: psi, kPa, bar, mbar, inHg, mmHg; Level: in, ft., mm, cm, m; Level: in, ft., mm, cm, m
	Method	Piezoresistive; Ceramic

Warranty ¹¹	<p>2 year - Sonde, RDO and sensor cap, temperature/conductivity, temperature only, turbidity (excluding pH/ORP)</p> <p>1 year - pH/ORP, chloride ISE, accessories</p> <p>90 Days - Nitrate and Ammonium ISE sensors</p> <p>Other: see warranty policy (www.in-situ.com/warranty)</p>
Notes	<p>Specifications are subject to change without notice. Android is a trademark of Google, Inc. Bluetooth is a trademark of Bluetooth SIG, Inc. Delrin and Tefzel are trademarks of E.I. du Pont de Nemours & Co. Santoprene is a trademark of ExxonMobile. Inconel is a trademark of Special Metals Corporation. Viton is a registered trademark of DuPont Performance Elastomers L.L.C.</p>

¹ Dependent on display and wiping

² Typical system response with instrument, sensors and restrictor when changing approximately 15° C in moderate flow

³ Response time at thermal equilibrium

⁴ Accuracy from calibration standard @ 25C, response-at thermal equilibrium immediately following calibration in ZoBell's measuring from air to +400 mV

⁵ Accuracy at calibration points

⁶ RDO sensor full range 0-50mg/L, 0-500% sat. EPA-approved under the Alternate Test Procedure process

⁷ User defined reference

⁸ Between 2 calibration points immediately following proper conditioning and calibration. Varies on site conditions and environmental interferences. See sensor summary sheet for potential interferences

⁹ Average response, can be longer with increasing concentrations of ammonium

¹⁰ Typical performance across full temperature and pressure calibrated range

¹¹ Extended warranty option for sonde only (1-3 year extension for up to 5 years total)

Potential Interferents

pH

Sodium salts

Dissolved Oxygen

Temperature, atmospheric pressure, salinity, chlorinity

Ammonium

Cesium, Potassium, Thallium, pH, Silver, Lithium, Sodium

Nitrate

Perchlorate, Iodide, Chlorate, Cyanide, Bromide, Nitrite, Hydrogen Sulfide (bisulfite), Hydrogen Carbonate (bicarbonate), Carbonate, Chloride, Dihydrogen Phosphate, Hydrogen Phosphate, Phosphate, Acetate, Fluoride, Sulfate

Conductivity

Temperature

ORP

Ions that are stronger reducing agents than hydrogen or platinum, e.g., chromium, vanadium, titanium

Chloride

Hydroxide, Ammonia, Thiosulfate, Bromide, Sulfide, Iodide, Cyanide

Ammonium, Chloride and Nitrate Interferent Concentrations

Ammonium

The table below lists concentrations of possible interfering ions that cause 10% error at various levels (in ppm) of NH_4^+ .

Ion	100 ppm NH_4^+	10 ppm NH_4^+	1 ppm NH_4^+
Cesium (Cs^+)	100	10	1
Potassium (K^+)	270	27	2.7
Thallium (Tl^+)	3100	310	31
pH (H^+)	pH 1.6	pH 2.6	pH 3.6
Silver (Ag^+)	270,000	27,000	2,700
Lithium (Li^+)	35,000	3,500	350
Sodium (Na^+)	11,100	1,100	110

Chloride

The table below lists concentrations of possible interfering ions that cause 10% error at various levels (in ppm) of Cl⁻.

Ion	100 ppm Cl ⁻	10 ppm Cl ⁻	1 ppm Cl ⁻
Hydroxide (OH ⁻)	3,840	384	38.4
Ammonia (NH ₃)	6	0.6	0.06
Thiosulfate (S ₂ O ₃ ²⁻)	3	0.3	0.03
Bromide (Br ⁻)	0.68	0.068	6.8 x 10 ⁻³
Sulfide (S ²⁻)	9 x 10 ⁻⁴	9 x 10 ⁻⁶	9 x 10 ⁻⁷
Iodide (I ⁻)	1.8 x 10 ⁻⁴	1.8 x 10 ⁻⁵	1.8 x 10 ⁻⁶
Cyanide (CN ⁻)	1.5 x 10 ⁻⁵	1.5 x 10 ⁻⁶	1.5 x 10 ⁻⁷

Nitrate

The table below lists concentrations of possible interfering ions that cause 10% error at various levels (in ppm) of NO₃⁻.

Ion	100 ppm NO ₃ ⁻ as N	10 ppm NO ₃ ⁻ as N	1 ppm NO ₃ ⁻ as N
Perchlorate (ClO ₄ ⁻)	7 x 10 ⁻²	7 x 10 ⁻³	7 x 10 ⁻⁴
Iodide (I ⁻)	4	0.4	0.04
Chlorate (ClO ₃ ⁻)	30	3	0.3
Cyanide (CN ⁻)	20	2	0.2
Bromide (Br ⁻)	400	40	4
Nitrite (NO ₂ ⁻)	230	23	2
Hydrogen Sulfide (HS ⁻)	230	23	2
Bicarbonate (HCO ₃ ⁻)	440	440	44
Carbonate (CO ₃ ²⁻)	8,600	860	86
Chloride (Cl ⁻)	7,600	760	76
Dihydrogen Phosphate (H ₂ PO ₄ ⁻)	34,640	3,464	346
Hydrogen Phosphate (HPO ₄ ²⁻)	34,300	3,430	343

Phosphate (PO ₄ ³⁻)	33,900	3,390	339
Acetate (OAc ⁻)	104,200	10,420	1,042
Fluoride (F ⁻)	81,400	8,140	814
Sulfate (SO ₄ ²⁻)	685,600	68,570	6,857

Conductivity Sensor Specifications

Accuracy	±0.5% of reading plus 1 µS/cm from 0 to 100,000 µS/cm; ±1.0% of reading from 100,000 to 200,000 µS/cm
Range	0 to 350,000 µS/cm
Resolution	0.1 µS/cm
Sensor Type	Removeable
Response Time	T63<1s, T90<3s, T95<5s
Units of Measure	Actual conductivity: µS/cm, mS/cm Specific conductivity: µS/cm, mS/cm Salinity: PSU Total dissolved solids: ppt, ppm Resistivity: Ohms-cm Density: g/cm ³
Methodology	Std. Methods 2510, EPA 120.1

*Accuracy at calibration points. For greatest accuracy over instrument life, keep the conductivity cell submerged in water for 24-48 hours prior to calibration and deployment.

Total Dissolved Solids

TDS is derived from conductivity and temperature.

Range	0 to 350 ppt
Resolution	0.1 ppt
Units of Measure	ppt, ppm

Salinity

Salinity is derived from pH, conductivity and temperature.

Range	0 to 350 ppt
Resolution	0.1 PSU
Units of Measure	PSU, ppt
Methodology	Std. Methods 2520A

Dissolved Oxygen RDO Sensor Specifications

Accuracy	± 0.1 mg/L from 0 to 8 mg/L ± 0.2 mg/L from 8 to 20 mg/L $\pm 10\%$ of reading from 20 to 50 mg/L
Range	0 to 8 mg/L 8 to 20 mg/L 20 to 50 mg/L Full operating range: 0 to 50 mg/L; 0 to 500% saturation
Resolution	0.01 mg/L
Sensor Type	Removable with replaceable RDO-X Cap
Response Time	RDO-X Cap: T63<15s, T90<45s, T95<60s
Units of Measure	mg/L, % saturation, ppm
Methodology	EPA-approved In-Situ Methods (under the Alternate Test Procedure process): 1002-8-2009, 1003-8-2009, 1004-8-2009

Level, Depth and Pressure Sensor Specifications

Accuracy	Typical $\pm 0.1\%$ full scale (FS)
Range	Non-vented or Vented 9.0 m (30 ft) - Burst: 27 m (90 ft) 30 m (100 ft) - Burst: 40 m (130 ft) 76 m (250 ft) - Burst: 107 m (350 ft) 100 m (325 ft) - Burst:
Resolution	$\pm 0.01\%$ FS or better
Sensor Type	Fixed
Response Time	T63 < 1s, T90 < 1s, T95 < 1s
Units of Measure	Pressure: psi, kPa, bar, mbar, mmHg, inHg, cmH ₂ O, inH ₂ O Level: mm, cm, m, in, ft, cmH ₂ O, inH ₂ O
Methodology	Piezoresistive; ceramic

*Typical performance across full temperature and pressure calibrated range. Typical is defined as all values within 1 standard deviation.

ORP Sensor Specifications

Accuracy	± 5.0 mV @ 25° C
Range	$\pm 1,400$ mV
Resolution	0.1 mV
Sensor Type	Replaceable pH/ORP combo sensor
Response Time	T63 < 3s, T90 < 15s, T95 < 30s
Units of Measure	mV
Methodology	Std. Methods 2580

*Accuracy from standard at 25° C.

**At thermal equilibrium immediately following calibration, measuring from air to +400 mV

pH Sensor Specifications

Accuracy	± 0.1 pH units or better
Range	0 to 14 pH units
Resolution	0.01 pH unit
Sensor Type	Replaceable pH/ORP combo sensor

Response Time	T63<1s, T90<2s, T95<3s
Units of Measure	pH units
Methodology	Std. Methods 4500-H+, EPA 150.2

*At thermal equilibrium.

Temperature Sensor Specifications

Accuracy	±0.1° C
Range	-5 to 50° C (23 to 122° F)
Resolution	0.01° C
Sensor Type	Replaceable
Response Time	T63<2s, T90<15s, T95<30s
Units of Measure	° C, ° F
Methodology	EPA 170.1

Sensor only, when transferring from air to ambient water temperature. Typical system response time with all sensors and restrictor installed: T63<30s; T90<3.5m; T95,7.5m

Turbidity Sensor Specifications

Accuracy	±2% of reading or ±2 NTU or FNU, whichever is greater
Range	0 to 4,000 NTU
Resolution	0.01 NTU (0 to 1,000 NTU) 0.1 NTU (1,000 to 4,000 NTU)
Sensor Type	Replaceable
Response Time	T63<1s, T90<1s, T95<1s
Units of Measure	NTU, FNU
Methodology	ISO 7027

Total Suspended Solids

TSS is derived from turbidity.

Range	0 to 1,500 mg/L
Resolution	0.1 mg/L
Units of Measure	ppt, mg/L

User-defined reference.

1-970-498-1500

Ammonium Sensor Specifications

Accuracy	±10% or ±2 mg/L, w.i.g.*
Max Depth	25 m, 30 PSI
Range	0-10,000 mg/L as N
Resolution	0.01 mg/L
Sensor Type	Removable
Response Time*	T90 < 10sec, T95 < 30sec
Units of Measure	mg/L, ppm, mV
Methodology	Std. Methods 4500-NH ₃ D, EPA 350.3

*Between calibration points.

Ammonia (Un-ionized Ammonia and Total Ammonia)

Ammonia is derived from ammonium, pH, salinity and temperature.

Range	0 to 10,000 mg/L
Resolution	0.01 mg/L
Units of Measure	mg/L, ppm

Chloride Sensor Specifications

Accuracy	±10% or ±2 mg/L, w.i.g.*
Range	0-190,000 mg/L - CL
Resolution	0.01 mg/L
Sensor Type	Removable
Response Time*	T90 < 10sec, T95 < 30sec
Units of Measure	mg/L, ppm, mV
Methodology	Std. Methods 4500-Cl-D

*Between calibration points.

Nitrate Sensor Specifications

Accuracy	$\pm 10\%$ or ± 2 mg/L, w.i.g.*
Max Depth	25 m, 30 PSI
Range	0-10,000 mg/L as N
Resolution	0.01 mg/L
Sensor Type	Removable
Response Time*	T90 < 10sec, T95 < 30sec
Units of Measure	mg/L, ppm, mV
Methodology	Std. Methods 4500-NO 3D

*Between calibration points.

More Information

! To learn more about the Aqua TROLL 500, telemetry, software and other In-Situ products, see the resources listed below.

1 **Visit www.in-situ.com**

Find information about In-Situ water quality, water level, telemetry and other products. Download software, manuals and product instructions.

2 **View the [In-Situ YouTube channel](#).**

Get video instructions for the Aqua TROLL 500 and other instruments. Watch quickstart videos and other tutorials.

3 **Call [In-Situ's technical support team](#).**

For further instructions and help with technical questions, call the In-Situ support line.

Appendix

Appendix A: Sensor Discovery

The first register read in a PLC measurement sequence should be the 2-register, 32-bit value starting with register number 9301. The read of these registers triggers the Aqua TROLL instrument to scan its sensor ports and update its sensor map. This guarantees that the sonde has properly registered any changes to the sensor configuration a user may have made since the last measurement sequence. The value of the register can be discarded.

Register Number	Holding Register Address	Size (Registers)	Mode & Access Level (R/W)	Data Type	Description
9301	9300	2	R	float	The read of these register triggers the Aqua TROLL 500 to scan its sensor ports and update its sensor map.

Appendix B: Parameter Numbers and Locations

ID	Parameter Name	Holding Register Number	Holding Register Address	Default Units
1	Temperature	5451	5450	1 = °C
2	Pressure	5458	5457	17 = PSI
3	Depth	5465	5464	38 = feet
4	Level, Depth to Water	5472	5471	38 = feet
5	Level, Surface Elevation	5479	5478	38 = feet
9	Actual Conductivity	5507	5506	65 = μS/cm
10	Specific Conductivity	5514	5513	65 = μS/cm
11	Resistivity	5521	5520	81 = ohm-cm
12	Salinity	5528	5527	97 = PSU
13	Total Dissolved Solids	5535	5534	114 = ppt
14	Density of Water	5542	5541	129 = g/cm ³
16	Barometric Pressure	5556	5555	22 = mmHg
17	pH	5563	5562	145 = pH
18	pH mV	5570	5569	162 = mV
19	ORP	5577	5576	162 = mV
20	Dissolved Oxygen Concentration	5584	5583	117 = mg/L
21	Dissolved Oxygen % Saturation	5591	5590	177 = % saturation
22	Nitrate (NO ₃ ⁻)	5598	5597	117 = mg/L
23	Ammonium (NH ₄ ⁺)	5605	5604	117 = mg/L
24	Chloride (Cl ⁻)	5612	5611	117 = mg/L
25	Turbidity	5619	5618	194 = NTU
26	Battery Voltage	5626	5625	163 = Volts

ID	Parameter Name	Holding Register Number	Holding Register Address	Default Units
30	Oxygen Partial Pressure	5654	5653	26 = torr
31	Total Suspended Solids	5661	5660	117 = mg/L
32	External Voltage	5668	5667	163 = Volts
33	Battery Capacity (remaining)	5675	5674	241 = %
34	Rhodamine WT Concentration	5682	5681	118 = µg/L
35	Rhodamine WT Fluorescence Intensity	5689	5688	257 = RFU
36	Chloride (Cl ⁻) mV	5696	5695	162 = mV
37	Nitrate as Nitrogen (NO ₃ as N) Concentration	5703	5702	117 = mg/L
38	Nitrate (NO ₃ ⁻) mV	5710	5709	162 = mV
39	Ammonium as Nitrogen (NH ₄ as N) Concentration	5717	5716	117 = mg/L
40	Ammonium (NH ₄) mV	5724	5723	162 = mg/L
41	Ammonia as Nitrogen (NH ₃ as N) Concentration	5731	5730	117 = mg/L
42	Total Ammonia as Nitrogen (NH ₃ as N) Concentration	5738	5737	117 = mg/L
48	Eh	5780	5779	162 = mg/L
49	Velocity	5787	5786	118 = µg/L
50	Chlorophyll-a Concentration	5894	5793	118 = µg/L
51	Chlorophyll-a Fluorescence Intensity	5801	5800	257 = RFU
54	Blue Green Algae-Phycocyanin Concentration	5822	5821	118 = µg/L
55	Blue Green Algae-Phycocyanin Fluorescence Intensity	5829	5828	257 = RFU
58	Blue Green Algae-Phycocerythrin Concentration	5850	5849	118 = µg/L
59	Blue Green Algae-Phycocerythrin Fluorescence Intensity	5857	5856	257 = RFU

Appendix C: Unit IDs

ID	Abbreviation	Units
Temperature		
1	C	Celsius
2	F	Fahrenheit
3	K	Kelvin
Pressure, Barometric Pressure (17-32)		
17	PSI	Pounds per square inch
18	Pa	Pascals
19	kPa	Kilopascals
20	Bar	Bars
21	mBar	Millibars
22	mmHg	Millimeters of Mercury (0° C)
23	inHg	Inches of Mercury (0° C)
24	cmH ₂ O	Centimeters of water (4° C)
25	inH ₂ O	Inches of water (4° C)
26	Torr	Torr
27	atm	Standard atmosphere
Distance/Length (33-48)		
33	mm	Millimeters
34	cm	Centimeters
35	m	Meters
36	km	Kilometers
37	in	Inches
38	ft	Feet
Coordinates (49-64)		
49	deg	Degrees
50	min	Minutes
51	sec	Seconds
Conductivity (65-80)		
65	μS/cm	Microsiemens per centimeter
66	mS/cm	Millisiemens per centimeter
Resistivity (81-96)		
81	ohm-cm	Ohm-centimeters
Salinity (97-112)		
97	PSU	Practical salinity units
98	ppt	Parts per thousand salinity
Concentration (113-128)		
113	ppm	Parts per million
114	ppt	Parts per thousand
115		(available)
116		(available)
117	mg/L	Milligrams per liter
118	μg/L	Micrograms per liter
119	---	(deprecated, no longer available)

120	g/L	Grams per liter
121	ppb	Parts per billion
Density		
129	g/cm ³	Grams per cubic centimeter
pH		
145	pH	pH
Voltage (161-176)		
161	μV	Microvolts
162	mV	Millivolts
163	V	Volts
Dissolved Oxygen (DO) % Saturation (177-192)		
177	% sat	Percent saturation
Turbidity (193-208)		
193	FNU	Formazin nephelometric units
194	NTU	Nephelometric turbidity units
195	FTU	Formazin turbidity units
Flow (209-224)		
209	ft ³ /s	Cubic feet per second
210		(available)
211		(available)
212	ft ³ /day	Cubic feet per day
213	gal/s	Gallons per second
214	gal/m	Gallons per minute
215	gal/hr	Gallons per hour
216	MGD	Millions of gallons per day
217	m ³ /sec	Cubic meters per second
218		(available)
219	m ³ /hr	Cubic meters per hour
220		(available)
221	L/s	Liters per second
222	ML/day	Millions of liters per day
223	mL/min	Milliliters per minute
224	kL/day	Thousands of liters per day
Volume (225-240)		
225	ft ³	Cubic feet
226	gal	Gallons
227	Mgal	Millions of gallons
228	m ³	Cubic meters
229	L	Liters
230	acre-ft	Acre feet
231	mL	Milliliters
232	ML	Millions of liters
233	kL	Thousands of liters
234	acre-in	Acre inches
% (241-256)		
241	%	Percent

Fluorescence		
257	RFU	Relative fluorescence units
Low-Flow (273-288)		
273	ml/sec	Milliliters per second
274	ml/hr	Milliliters per hour
275	l/min	Liters per minute
276	l/hr	Liters per hour
Current (289-304)		
289	μA	Microamps
290	mA	Milliamps
291	A	Amps
Velocity		
305	ft/s	Feet per second
306	m/s	Meters per second

Appendix D: Register Data Formats

The Modbus protocol specification requires any multiple-byte data type to be transmitted in Big Endian order, or most significant byte (MSB) first. In-Situ devices shall use the following register data formats.

ID	Type	Size (Registers)	Description
2	Unsigned Short	1	2 bytes, 1 register, MSB first
5	Float	2	4 bytes, 2 registers. IEEE floating point format